

AKSESUAR KATALOĀU

SCHÖNLINE



Aksesuar Katalođu

Tek Açılım İspanyoletler.....	02-03
Çift Açılım Sistemleri.....	04-11
Tek Açılım ve Çift Açılım Mentşeleri.....	12
Vasistas Sistemi.....	13
Basit Vasistas Sistemleri ve Aksesuarları.....	14
Pencere ve Kapı Kolları.....	15-17
Kilitler ve Bareller.....	18-19
Bađlantı Elemanları ve Karşılıklar.....	20
Sürme Aksesuarlar.....	21-21
Paralel Çek-Sür Sistemleri.....	23-29
Vidalar.....	30
Contalar ve Destek Sacları.....	31
Plastik Malzemeler.....	32-33
Sineklik Aksesuarları.....	34-37
İzolasyon Malzemeleri.....	37
Isıcam Çıtaları ve Kimyasalları.....	38
Cam Balkon Line Eşiksiz - X Line Eşikli Sürgülü Sistem.....	39-41
Cam Balkon Askılı Vitrin Sistem.....	42-44
Cam Balkon Ultra Katlanır Sistem.....	45-48

Tek Açılım İspanyoletleri



Tek Açılım

Kod	Ölçü	Koli Adedi
Combi 15 mm		
U.12000.04.0.1	400 mm	10
U.12000.06.0.1	600 mm	10
U.12000.08.0.1	800 mm	10
U.12000.09.0.1	900 mm	10
U.12000.10.0.1	1000 mm	10
U.12000.11.0.1	1100 mm	10
U.12000.12.0.1	1200 mm	10
U.12000.13.0.1	1300 mm	10
U.12000.14.0.1	1400 mm	10
U.12000.15.0.1	1500 mm	10
U.12000.16.0.1	1600 mm	10
U.12000.19.0.1	1900 mm	10
U.12000.21.0.1	2100 mm	10

Inline 15 mm		
G.19643.04.0.1	400 mm	10
G.19643.06.0.1	600 mm	10
G.19643.07.0.1	700 mm	10
G.19643.08.0.1	800 mm	10
G.19643.09.0.1	900 mm	10
G.19643.10.0.1	1000 mm	10
G.19643.11.0.1	1100 mm	10
G.19643.12.0.1	1200 mm	10
G.19643.13.0.1	1300 mm	10
G.19643.14.0.1	1400 mm	10
G.19643.15.0.1	1500 mm	10
G.19643.16.0.1	1600 mm	10
G.19643.18.0.1	1800 mm	10
G.19643.20.0.1	2000 mm	10



Smart Kilitli Kapı - Güvenlikli (Yaylı Dil + Barel Dilli / Koldan Kumandalı)

Kod	Ölçü	Koli Adedi
6-33630-00-0-1	1800 mm	10
6-33631-00-0-1	2285 mm	10



Cygnus (Yaylı / Dilli Koldan Kumandalı)

Kod	Ölçü	Koli Adedi
35 / 85 mm		
U.322101.16.0.1	1600 mm	10
U.322101.18.0.1	1800 mm	10

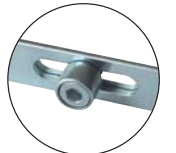



Tek Açılım

Kod	Ölçü	Koli Adedi
15 mm		
260129	180-250 mm	10
260130	251-500 mm	10
260131	501-800 mm	10
260132	801-1100 mm	10
260133	1101-1400 mm	10
260134	1401-1800 mm	10
260135	1801-2400 mm	10

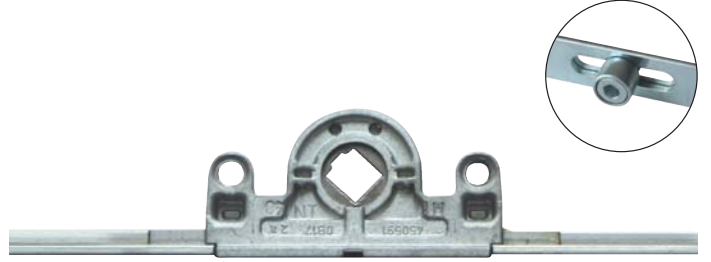

Kilitli Kapı

Kod	Ölçü	Koli Adedi
35 / 85 mm		
160200392	180 mm	10
160200393	200 mm	10



Tek Açılım

Kod	Ölçü	Koli Adedi
Zamak 15 mm		
110.021.215.200	210-280 mm	50
110.028.215.200	280-400 mm	50
110.040.215.200	400-600 mm	50
110.060.215.200	600-800 mm	50
110.080.215.200	800-1000 mm	50
110.100.215.200	1000-1200 mm	50
110.120.215.200	1200-1400 mm	50
110.140.215.200	1400-1600 mm	25
110.160.215.200	1600-1800 mm	25
110.180.215.200	1800-2000 mm	25
110.200.215.200	2000-2200 mm	25



Sac 15 mm

115.021.215.100	210-280 mm	50
115.028.215.100	280-400 mm	50
115.040.215.100	400-600 mm	50
115.060.215.100	600-800 mm	50
115.080.215.100	800-1000 mm	50
115.100.215.100	1000-1200 mm	50
115.120.215.100	1200-1400 mm	50
115.140.215.100	1400-1600 mm	25
115.160.215.100	1600-1800 mm	25
115.180.215.100	1800-2000 mm	25
115.200.215.100	2000-2200 mm	25



Kilitli Kapı

Kod	Ölçü	Koli Adedi
Fornax Action 35 / 85 mm		
170.160.185.135	1600-1800 mm	10
170.160.285.135	1600-1800 mm	10
170.160.385.135	1600-1800 mm	10
170.180.185.135	1800-2000 mm	10
170.180.285.135	1800-2000 mm	10
170.180.385.135	1800-2000 mm	10
170.200.185.135	2000-2200 mm	10
170.200.285.135	2000-2200 mm	10
170.200.385.135	2000-2200 mm	10



Çift Açılım Sistemleri

Roto CS Çift Kanat Çift Açılım

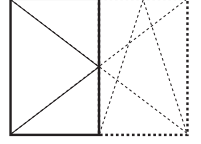

Üst menteşe ve pimi

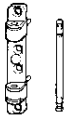

Tek açılım menteşe

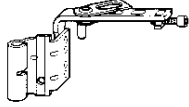

Standart karşılık



Standart karşılık



Üst-Arka kilitleme

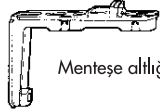

Menteşe altlığı

Köşe elemanı

Roto CS Çift Kanat Çift Açılım Ölçü ve Kodları

BOY	EN	410-610 mm	611-810 mm	811-1010 mm	1011-1210 mm
	KOD	KOD	KOD	KOD	KOD
461-600 mm		CS-205	CS-215	CS-225	CS-235
601-800 mm		CS-206	CS-216	CS-226	CS-236
801-1000 mm		CS-207	CS-217	CS-227	CS-237
1001-1200 mm		CS-208	CS-218	CS-228	CS-238
1201-1400 mm		CS-209	CS-219	CS-229	CS-239
1401-1600 mm		CS-210	CS-220	CS-230	CS-240
1601-1800 mm		CS-211	CS-221	CS-231	CS-241
1801-2000 mm		CS-212	CS-222	CS-232	CS-242
2001-2200 mm		CS-213	CS-223	CS-233	CS-243
2201-2400 mm		CS-214	CS-224	CS-234	CS-244

- * Sisteme kol dahil değildir.
- * Sisteme ende ve boyda 1000 mm.'den sonra alt e arka kilitleme dahildir.
- * Sisteme karşılıklar dahildir.
- * Siparişlerinizde sağ ve sol açılım bildiriniz.
- * Siparişlerinizde menteşe kapak rengini aşağıdaki kodlarımıza göre belirtiniz.

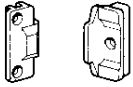

Orta gizli baskı

Gizli ispanyolet

İspanyolet üstü karşılık

Köşe elemanı

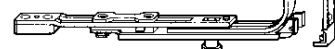

Alt menteşe kanat



Alt menteşe kasa

Alt-Arka kilitleme



Standart karşılık



Standart karşılık

Menteşe Kapak Renkleri



Beyaz
SC1



Gümüş
SC2



Şampanya
SC3



Altın
SC4



Koyu Kahve
SC6

Roto CS Çift Açılım

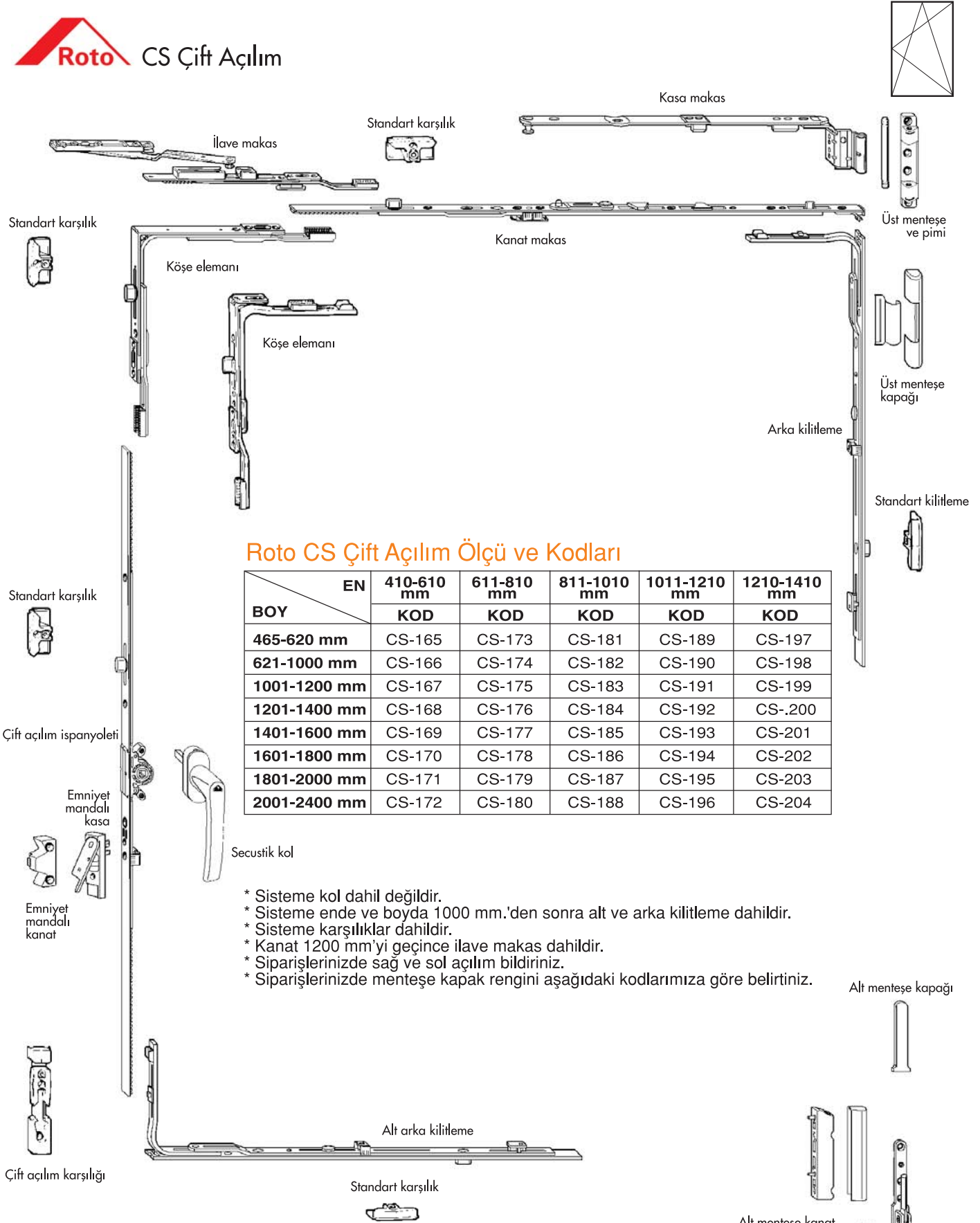

Roto CS Çift Açılım Ölçü ve Kodları

BOY	EN	410-610 mm	611-810 mm	811-1010 mm	1011-1210 mm	1210-1410 mm
	KOD	KOD	KOD	KOD	KOD	KOD
465-620 mm	CS-165	CS-173	CS-181	CS-189	CS-197	
621-1000 mm	CS-166	CS-174	CS-182	CS-190	CS-198	
1001-1200 mm	CS-167	CS-175	CS-183	CS-191	CS-199	
1201-1400 mm	CS-168	CS-176	CS-184	CS-192	CS-200	
1401-1600 mm	CS-169	CS-177	CS-185	CS-193	CS-201	
1601-1800 mm	CS-170	CS-178	CS-186	CS-194	CS-202	
1801-2000 mm	CS-171	CS-179	CS-187	CS-195	CS-203	
2001-2400 mm	CS-172	CS-180	CS-188	CS-196	CS-204	

- * Sisteme kol dahil değildir.
- * Sisteme ende ve boyda 1000 mm.'den sonra alt ve arka kilitleme dahildir.
- * Sisteme karşılıklar dahildir.
- * Kanat 1200 mm'yi geçince ilave makas dahildir.
- * Siparişlerinizde sağ ve sol açılım bildiriniz.
- * Siparişlerinizde menteşe kapak rengini aşağıdaki kodlarımıza göre belirtiniz.

Menteşe Kapak Renkleri

Beyaz SC1	Gümüş SC2	Şampanya SC3	Altın SC4	Koyu Kahve SC6

Çift Açılım Sistemleri

Roto NT Çift Kanat Çift Açılım

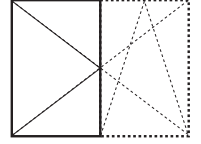

Üst menteşe ve pimi

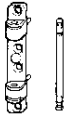

Tek açılım menteşe

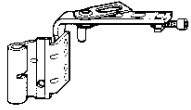

Standart karşılık



Standart karşılık



Üst-Arka kilitleme



Menteşe altlığı

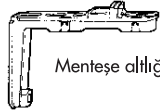

Köşe elemanı

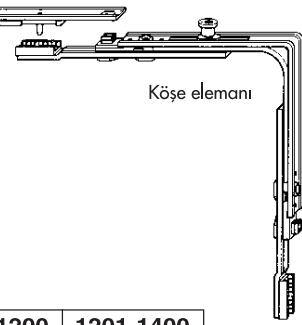

Roto NT Çift Kanat Çift Açılım Ölçü ve Kodları

BOY	EN	290-410 mm	411-600 mm	601-800 mm	801-1000 mm	1001-1200 mm	1201-1400 mm
	KOD	KOD	KOD	KOD	KOD	KOD	KOD
310-450 mm	NT-043	NT-050	NT-057	NT-064	NT-071	NT-078	
451-620 mm	NT-044	NT-051	NT-058	NT-065	NT-072	NT-079	
621-800 mm	NT-045	NT-052	NT-059	NT-066	NT-073	NT-080	
801-1200 mm	NT-046	NT-053	NT-060	NT-067	NT-074	NT-081	
1201-1600 mm	NT-047	NT-054	NT-061	NT-068	NT-075	NT-082	
1601-2000 mm	NT-048	NT-055	NT-062	NT-069	NT-076	NT-083	
2001-2400 mm	NT-049	NT-056	NT-063	NT-070	NT-077	NT-084	

- * Sisteme kol dahil değildir.
- * Sisteme ende ve boyda 1000 mm.'den sonra alt ve arka kilitleme dahildir.
- * Sisteme karşılıklar dahildir.
- * Siparişlerinizde sağ ve sol açılım bildiriniz.
- * Siparişlerinizde menteşe kapak rengini aşağıdaki kodlarımıza göre belirtiniz.

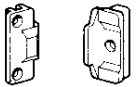

Orta gizli baskı

Gizli ispanyolet

İspanyolet üstü karşılık

Alt menteşe kanat

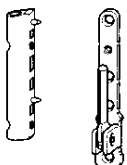

Alt menteşe kasa



Alt-Arka kilitleme



Standart karşılık



Emniyetli karşılık

Köşe elemanı

Menteşe Kapak Renkleri



Beyaz
SC1



Gümüş
SC2



Şampanya
SC3



Altın
SC4



Koyu Kahve
SC6

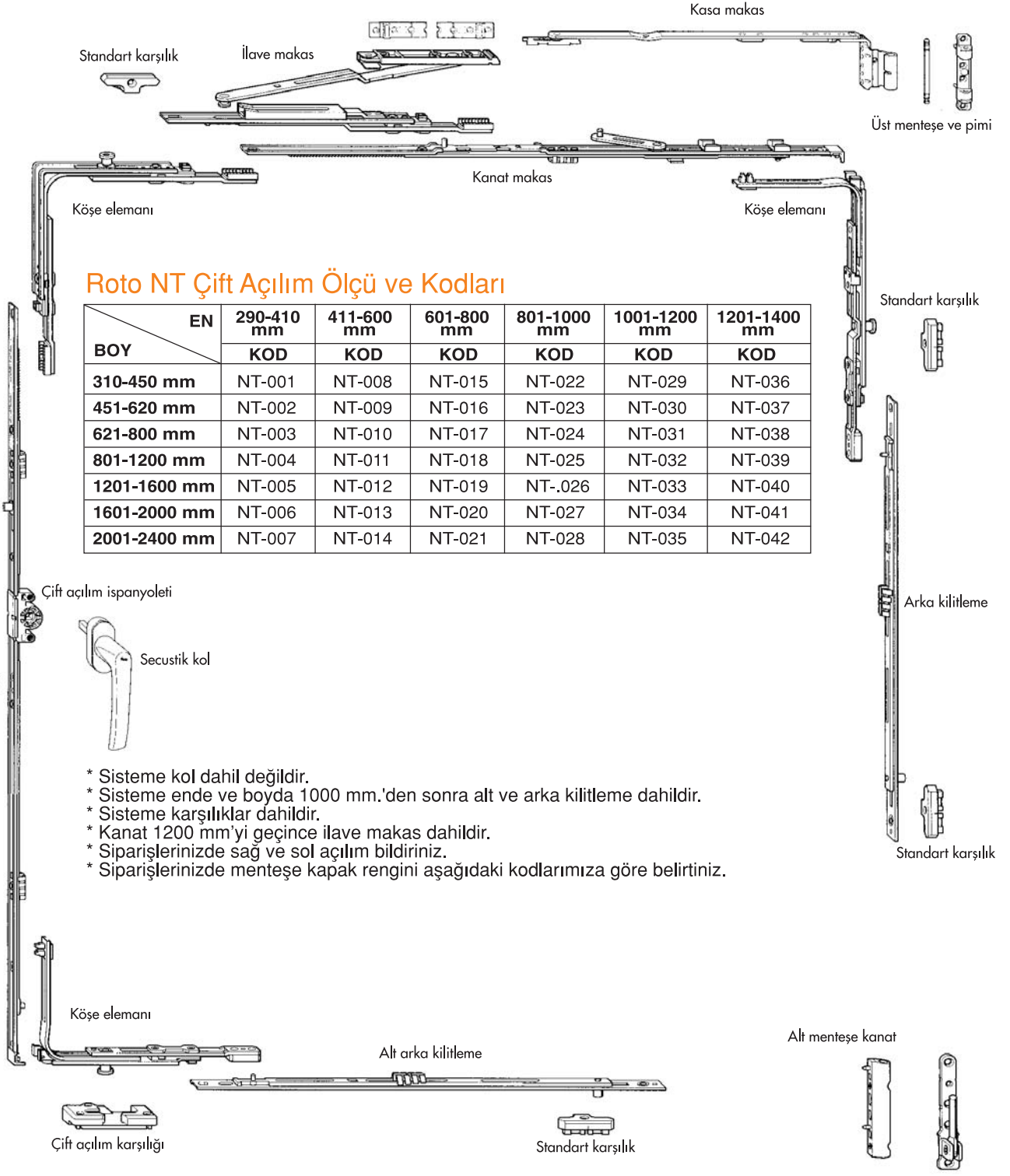
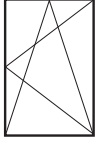

Roto NT Çift Açılım Ölçü ve Kodları

BOY	EN	290-410 mm	411-600 mm	601-800 mm	801-1000 mm	1001-1200 mm	1201-1400 mm
	KOD	KOD	KOD	KOD	KOD	KOD	KOD
310-450 mm	NT-001	NT-008	NT-015	NT-022	NT-029	NT-036	NT-036
451-620 mm	NT-002	NT-009	NT-016	NT-023	NT-030	NT-037	NT-037
621-800 mm	NT-003	NT-010	NT-017	NT-024	NT-031	NT-038	NT-038
801-1200 mm	NT-004	NT-011	NT-018	NT-025	NT-032	NT-039	NT-039
1201-1600 mm	NT-005	NT-012	NT-019	NT-026	NT-033	NT-040	NT-040
1601-2000 mm	NT-006	NT-013	NT-020	NT-027	NT-034	NT-041	NT-041
2001-2400 mm	NT-007	NT-014	NT-021	NT-028	NT-035	NT-042	NT-042

- * Sisteme kol dahil değildir.
- * Sisteme ende ve boyda 1000 mm.'den sonra alt ve arka kilitleme dahildir.
- * Sisteme karşılıklar dahildir.
- * Kanat 1200 mm'yi geçince ilave makas dahildir.
- * Siparişlerinizde sağ ve sol açılım bildiriniz.
- * Siparişlerinizde menteşe kapak rengini aşağıdaki kodlarımıza göre belirtiniz.

Menteşe Kapak Renkleri



Çift Açılım Sistemleri

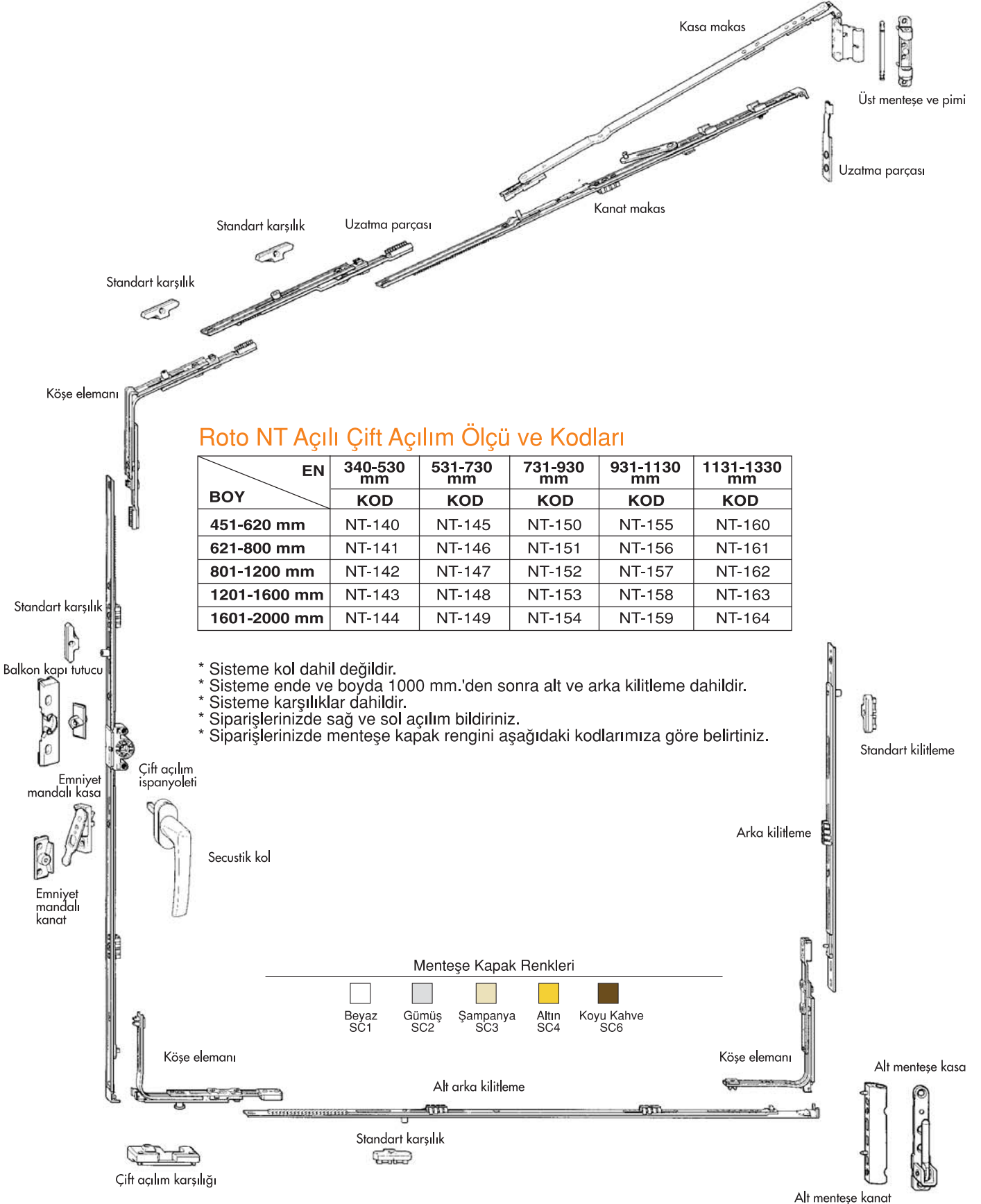
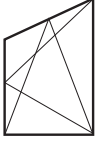

Roto NT Açılı Çift Açılım Ölçü ve Kodları

BOY	EN	340-530 mm	531-730 mm	731-930 mm	931-1130 mm	1131-1330 mm
	KOD	KOD	KOD	KOD	KOD	KOD
451-620 mm	NT-140	NT-145	NT-150	NT-155	NT-160	
621-800 mm	NT-141	NT-146	NT-151	NT-156	NT-161	
801-1200 mm	NT-142	NT-147	NT-152	NT-157	NT-162	
1201-1600 mm	NT-143	NT-148	NT-153	NT-158	NT-163	
1601-2000 mm	NT-144	NT-149	NT-154	NT-159	NT-164	

- * Sisteme kol dahil değildir.
- * Sisteme ende ve boyda 1000 mm.'den sonra alt ve arka kilitleme dahildir.
- * Sisteme karşılıklar dahildir.
- * Siparişlerinizde sağ ve sol açılım bildiriniz.
- * Siparişlerinizde menteşe kapak rengini aşağıdaki kodlarımıza göre belirtiniz.

Menteşe Kapak Renkleri

Beyaz SC1	Gümüş SC2	Şampanya SC3	Altın SC4	Koyu Kahve SC6



Roto NT Kemerli Çift Açılım

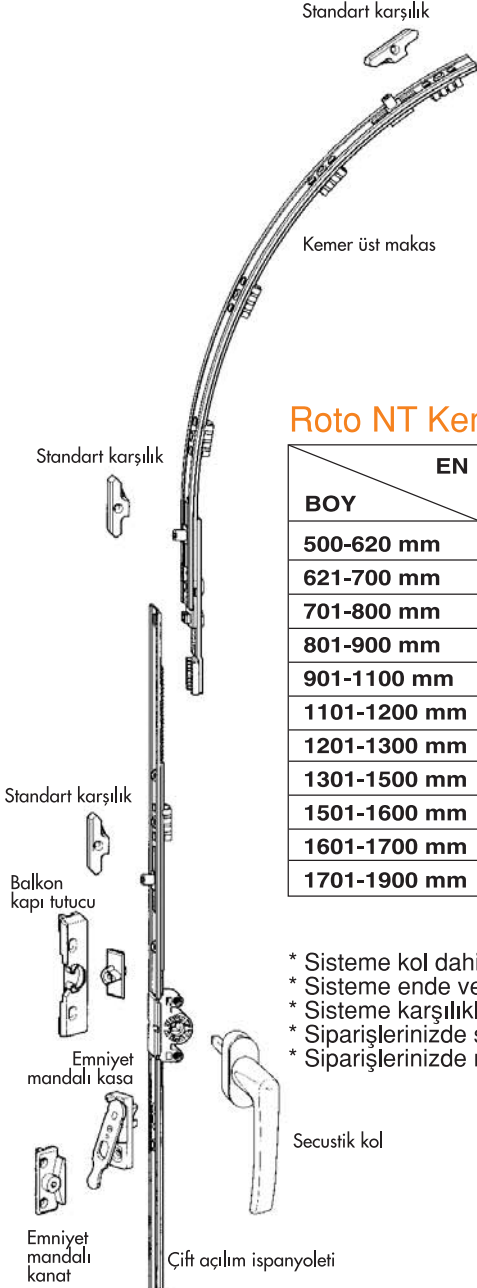
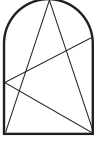

Roto NT Kemerli Çift Açılım Ölçü ve Kodları

BOY	EN	400-500 mm	501-700 mm	701-900 mm	901-1100 mm	1101-1300 mm
		KOD	KOD	KOD	KOD	KOD
500-620 mm		NT-085	NT-096	NT-107	NT-118	NT-129
621-700 mm		NT-086	NT-097	NT-108	NT-119	NT-130
701-800 mm		NT-087	NT-098	NT-109	NT-120	NT-131
801-900 mm		NT-088	NT-099	NT-110	NT-121	NT-132
901-1100 mm		NT-089	NT-100	NT-111	NT-122	NT-133
1101-1200 mm		NT-090	NT-101	NT-112	NT-123	NT-134
1201-1300 mm		NT-091	NT-102	NT-113	NT-124	NT-135
1301-1500 mm		NT-092	NT-103	NT-114	NT-125	NT-136
1501-1600 mm		NT-093	NT-104	NT-115	NT-126	NT-137
1601-1700 mm		NT-094	NT-105	NT-116	NT-127	NT-138
1701-1900 mm		NT-095	NT-106	NT-117	NT-128	NT-139

- * Sisteme kol dahil değildir.
- * Sisteme ende ve boyda 1000 mm.'den sonra alt ve arka kilitleme dahildir.
- * Sisteme karşılıklar dahildir.
- * Siparişlerinizde sağ ve sol açılım bildiriniz.
- * Siparişlerinizde menteşe kapak rengini aşağıdaki kodlarımıza göre belirtiniz.

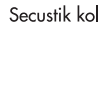

Çift açılım ispanyoleti

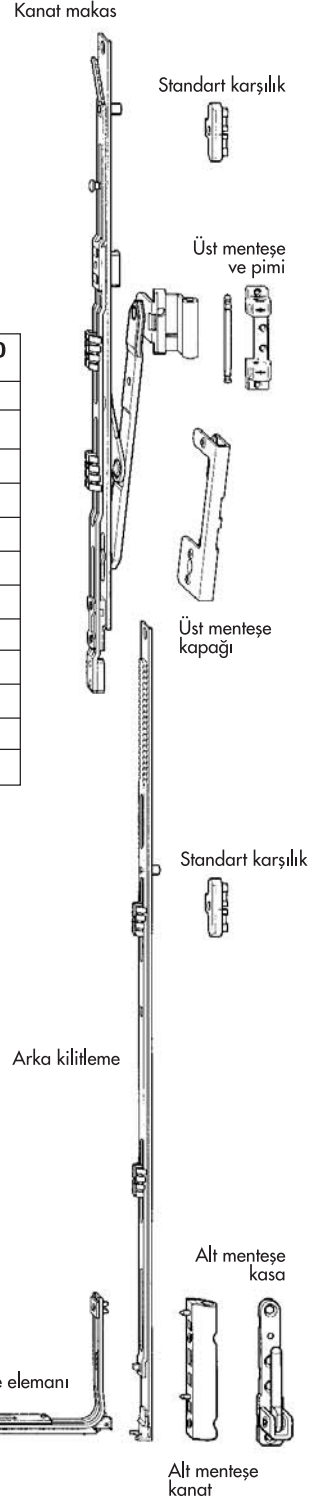

Menteşe Kapak Renkleri

Beyaz SC1	Gümüş SC2	Şampanya SC3	Altın SC4	Koyu Kahve SC6

Köşe elemanı

Alt arka kilitleme

Köşe elemanı



Çift açılım karşılığı



Standart karşılık

Çift Açılım Sistemleri

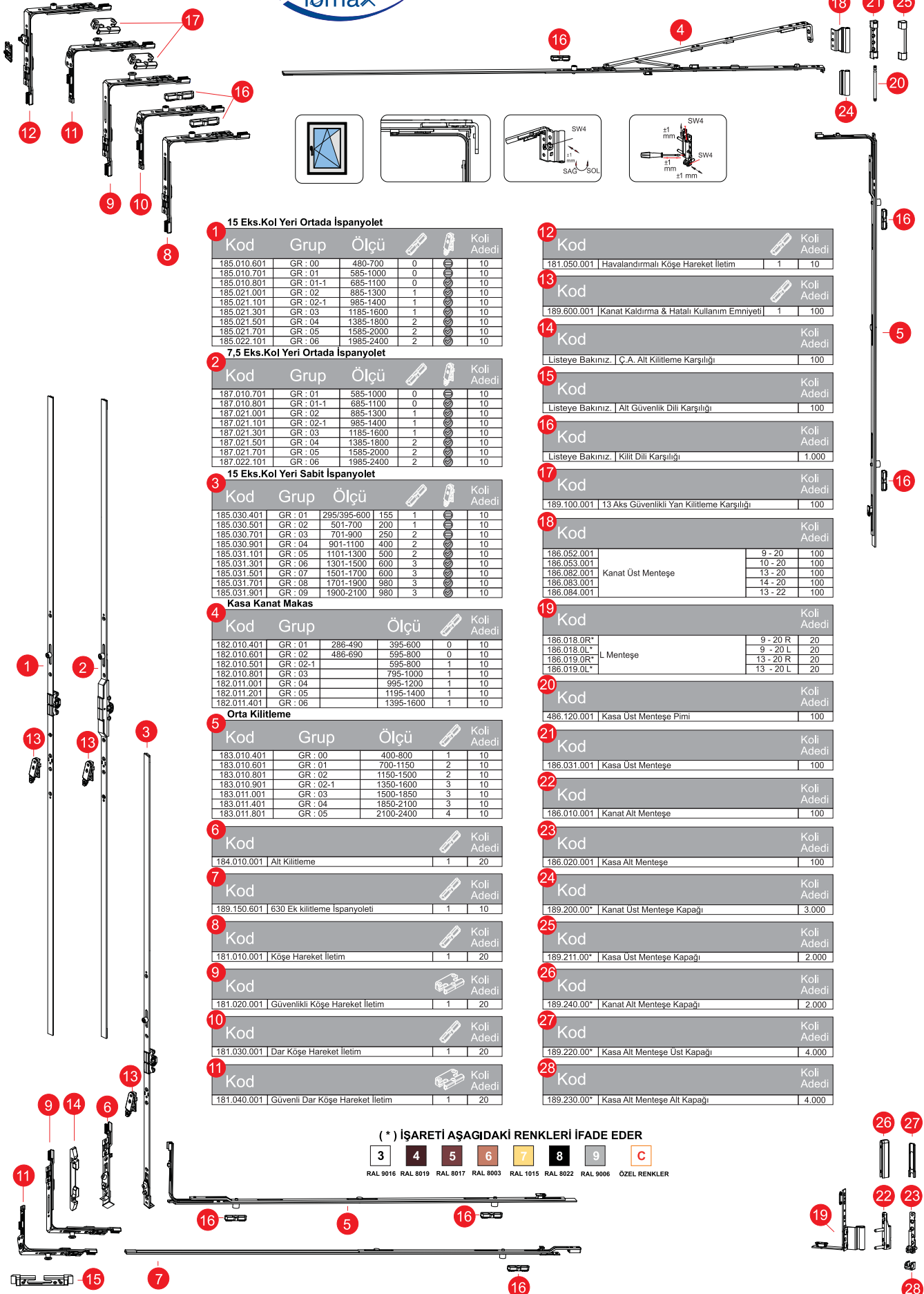

15 Eks.Kol Yeri Ortada İspanyolet

Kod	Grup	Ölçü	Koli Adedi
185.010.601	GR : 00	480-700	0
185.010.701	GR : 01	585-1000	0
185.010.801	GR : 01-1	685-1100	0
185.021.001	GR : 02	885-1300	1
185.021.101	GR : 02-1	985-1400	1
185.021.301	GR : 03	1185-1600	1
185.021.501	GR : 04	1385-1800	2
185.021.701	GR : 05	1585-2000	2
185.022.101	GR : 06	1985-2400	2

7,5 Eks.Kol Yeri Ortada İspanyolet

Kod	Grup	Ölçü	Koli Adedi
187.010.701	GR : 01	585-1000	0
187.010.801	GR : 01-1	685-1100	0
187.021.001	GR : 02	885-1300	1
187.021.101	GR : 02-1	985-1400	1
187.021.301	GR : 03	1185-1600	1
187.021.501	GR : 04	1385-1800	2
187.021.701	GR : 05	1585-2000	2
187.022.101	GR : 06	1985-2400	2

15 Eks.Kol Yeri Sabit İspanyolet

Kod	Grup	Ölçü	Koli Adedi
185.030.401	GR : 01	295/395-600	155
185.030.501	GR : 02	501-700	200
185.030.701	GR : 03	701-900	250
185.030.901	GR : 04	901-1100	400
185.031.101	GR : 05	1101-1300	500
185.031.301	GR : 06	1301-1500	600
185.031.501	GR : 07	1501-1700	600
185.031.701	GR : 08	1701-1900	980
185.031.901	GR : 09	1900-2100	980

Kasa Kanat Makas

Kod	Grup	Ölçü	Koli Adedi
182.010.401	GR : 01	286-490	0
182.010.601	GR : 02	486-690	0
182.010.501	GR : 02-1	595-800	1
182.010.801	GR : 03	795-1000	1
182.011.001	GR : 04	995-1200	1
182.011.201	GR : 05	1195-1400	1
182.011.401	GR : 06	1395-1600	1

Orta Kilitleme

Kod	Grup	Ölçü	Koli Adedi
183.010.401	GR : 00	400-800	1
183.010.601	GR : 01	700-1150	2
183.010.801	GR : 02	1150-1500	2
183.010.901	GR : 02-1	1350-1600	3
183.011.001	GR : 03	1500-1850	3
183.011.401	GR : 04	1850-2100	3
183.011.801	GR : 05	2100-2400	4

Kod

184.010.001	Alt Kilitleme	1	20
-------------	---------------	---	----

Kod

189.150.601	630 Ek kilitleme İspanyolet	1	10
-------------	-----------------------------	---	----

Kod

181.010.001	Köşe Hareket İletim	1	20
-------------	---------------------	---	----

Kod

181.020.001	Güvenlikli Köşe Hareket İletim	1	20
-------------	--------------------------------	---	----

Kod

181.030.001	Dar Köşe Hareket İletim	1	20
-------------	-------------------------	---	----

Kod

181.040.001	Güvenli Dar Köşe Hareket İletim	1	20
-------------	---------------------------------	---	----

Kod

181.050.001	Havalandırmalı Köşe Hareket İletim	1	10
-------------	------------------------------------	---	----

Kod

189.600.001	Kanat Kaldırma & Hatalı Kullanım Emniyeti	1	100
-------------	---	---	-----

Kod

Listeye Bakınız. Ç.A. Alt Kilitleme Karşılığı	100
---	-----

Kod

Listeye Bakınız. Alt Güvenlik Dili Karşılığı	100
--	-----

Kod

Listeye Bakınız. Kilit Dili Karşılığı	1.000
---	-------

Kod

189.100.001	13 Aks Güvenlikli Yan Kilitleme Karşılığı	100
-------------	---	-----

Kod

186.052.001	Kanat Üst Menteşe	9 - 20	100
186.053.001		10 - 20	100
186.082.001		13 - 20 R	100
186.083.001		14 - 20	100
186.084.001		13 - 22	100

Kod

186.018.0R*	L Menteşe	9 - 20 R	20
186.018.0L*		9 - 20 L	20
186.019.0R*		13 - 20 R	20
186.019.0L*		13 - 20 L	20

Kod

486.120.001	Kasa Üst Menteşe Pimi	100
-------------	-----------------------	-----

Kod

186.031.001	Kasa Üst Menteşe	100
-------------	------------------	-----

Kod

186.010.001	Kanat Alt Menteşe	100
-------------	-------------------	-----

Kod

186.020.001	Kasa Alt Menteşe	100
-------------	------------------	-----

Kod

189.200.00*	Kanat Üst Menteşe Kapağı	3.000
-------------	--------------------------	-------

Kod

189.211.00*	Kasa Üst Menteşe Kapağı	2.000
-------------	-------------------------	-------

Kod

189.240.00*	Kanat Alt Menteşe Kapağı	2.000
-------------	--------------------------	-------

Kod

189.220.00*	Kasa Alt Menteşe Üst Kapağı	4.000
-------------	-----------------------------	-------

Kod

189.230.00*	Kasa Alt Menteşe Alt Kapağı	4.000
-------------	-----------------------------	-------

(*) İŞARETİ AŞAĞIDAKİ RENKLERİ İFADE EDER

3	4	5	6	7	8	9	C
RAL 9016	RAL 8019	RAL 8017	RAL 8003	RAL 1015	RAL 8022	RAL 9006	ÖZEL RENKLER

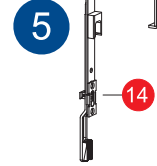
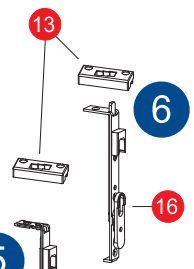
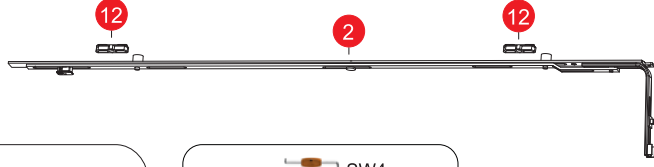
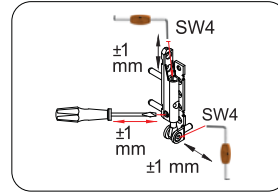
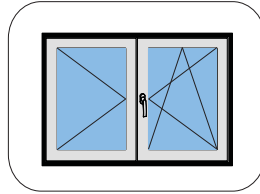
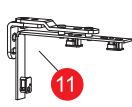
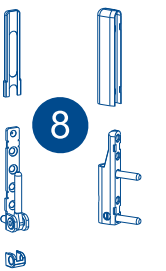
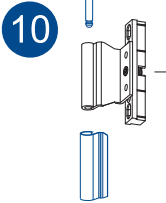
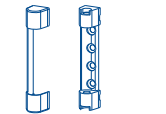
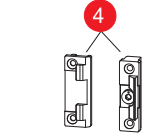
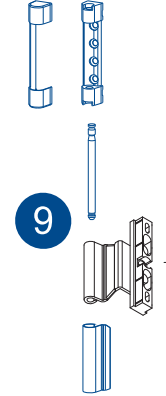
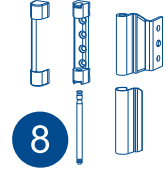

1 Çift Kanat İspanyolet

Kod	Grup	Ölçü	Koli Adedi
188.010.701	GR : 01	585-1000	0
188.021.001	GR : 02	885-1300	1
188.021.301	GR : 03	1185-1600	1
188.021.501	GR : 04	1385-1800	2
188.021.701	GR : 05	1585-2000	2
188.022.101	GR : 06	1985-2400	2

2 Orta Kilitleme

Kod	Grup	Ölçü	Koli Adedi
183.010.401	GR : 00	400-800	1
183.010.601	GR : 01	700-1150	2
183.010.801	GR : 02	1150-1500	2
183.010.901	GR : 02-1	1350-1600	3
183.011.001	GR : 03	1500-1850	3
183.011.401	GR : 04	1850-2100	3
183.011.801	GR : 05	2100-2400	4

3

Kod	Koli Adedi
186.019.0R*	L. Menteşe 13 - 20 R 10
186.019.0L*	13 - 20 L 10

4

Kod	Koli Adedi
189.091.001	10-20 10
189.130.001	13-20 10
189.131.001	14-20 10
189.132.001	13-22 10

5

Kod	Koli Adedi
189.450.011	İspanyolet Sürgü Seti 13 Aks 2 10

6

Kod	Koli Adedi
189.430.011	Üst Sürgü Seti 13 Aks 1 10

7

Kod	Koli Adedi
189.410.011	Alt Sürgü Seti 13 Aks 1 10

8

Kod	Koli Adedi
189.380.01*	Menteşe Seti (Kapaklı) 13-20 1 10

9

Kod	Koli Adedi
189.150.01*	Orta Baskı Menteşe Seti 13-20 10

10

Kod	Koli Adedi
189.170.01*	Orta Baskı Menteşe Seti (Vidalı) 13-20 10

11

Kod	Koli Adedi
186.100.001	Üst Menteşe Ana Gövde 10

12

Kod	Koli Adedi
Listeye Bakınız. Kilit Dili Karşılığı	10

13

Kod	Koli Adedi
186.250.001	Sürgü Karşılığı 13 Aks 10

14

Kod	Koli Adedi
186.280.001	İspanyolet Üst Sürgü Gövde 10

15

Kod	Koli Adedi
186.290.001	İspanyolet Alt Sürgü Gövde 10

16

Kod	Koli Adedi
186.260.001	Üst Sürgü Gövde 10

17

Kod	Koli Adedi
186.270.001	Alt Sürgü Gövde 10

18

Kod	Koli Adedi
189.210.001	Orta Baskı Menteşe Ana Gövde 13-20 10

19

Kod	Koli Adedi
189.230.001	Orta Baskı Menteşe Ana Gövde (Vidalı) 13-20 10

(*) İŞARETİ AŞAĞIDAKİ RENKLERİ İFADE EDER

3	4	5	6	7	8	9	C
RAL 9016	RAL 8019	RAL 8017	RAL 8003	RAL 1015	RAL 8022	RAL 9006	ÖZEL RENKLER

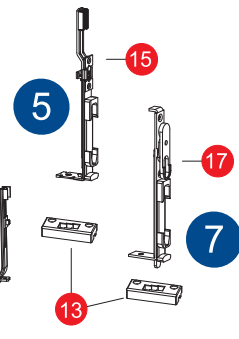
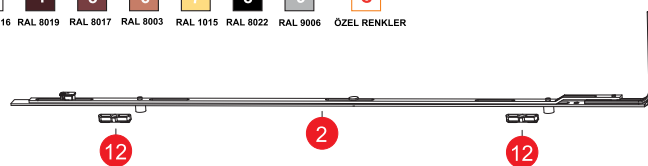

Tek Açılım ve Çift Açılım Mentешeleri

SCHÖNLINE®

Kod	Açıklama	Koli Adedi
001.001	90 mm	100
001.013	75 mm	150

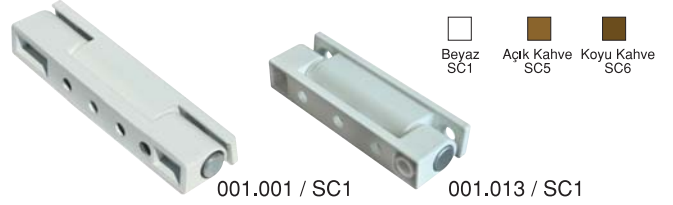

Roto

Kod	Açıklama	Koli Adedi
230.177	Kasa Üst	10
258.590	Kasa Alt	10
230.343	Kanat Alt	10
264.015	Orta	10
331.485	Gizli Orta Baskı Takım	10

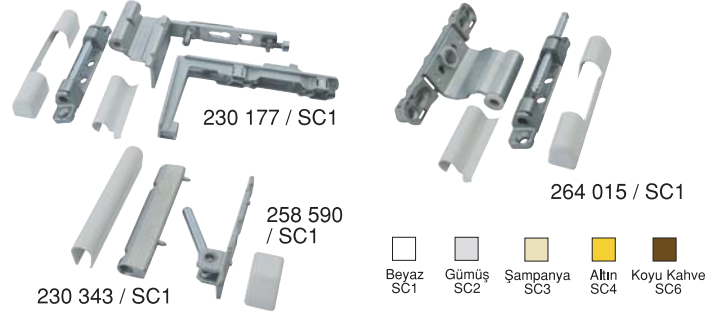

fornax®

Çift Kanat sistemleri

Kod	Açıklama	Koli Adedi
189.380.01	Menteşe Seti 13 aks	20
186.130.001	Gizli Orta Mentешe 13-20 aks	100
186.132.001	Gizli Orta Mentешe 13-22 aks	100
186.150.001	Orta Baskı Mentешe 13-20 aks	20
186.160.001	Orta Baskı Mentешe (vidalı) 13-20 aks	20
186.160.002	Orta Baskı Mentешe (vidalı) 13-22 aks	20
186.310.01	Orta Baskı Mentешe (kapaklı) 9-20 aks	100
186.300.001	Ayarlı Orta Baskı Mentешe (3D)	100
186.019.0R1	L Mentешe 13-20 aks	20
186.019.0L1	L Mentешe 13-20 aks	20



Roto

Ayarlı Kapı

Kod	Açıklama	Koli Adedi
224.738	90'lık	24



fornax®

Ayarlı Kapı Pavo

Kod	Açıklama	Koli Adedi
130.125.019	90'lık	24

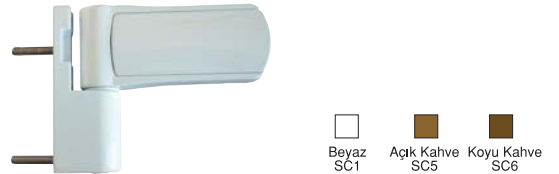

SFS intec

Kod	Açıklama	Koli Adedi
11R.15.013	Ayarlı Kapı kanat	24
11R.15.014	Ayarlı Kapı kanat	24
170.15.M09	Pencere kanat	24

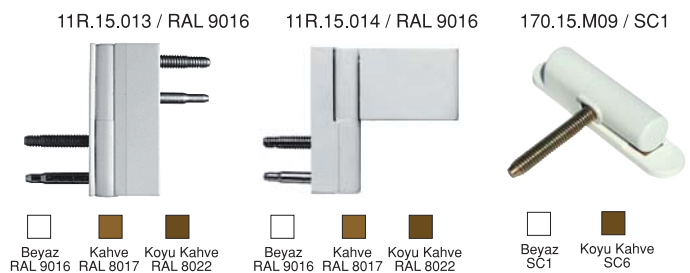



Vasistas makas

İspanyolet ve karşılığı

Köşe elemanı ve karşılığı

Köşe elemanı ve karşılığı

Arka kilitleme ve karşılığı

Arka kilitleme ve karşılığı

264 015 /SC1

264 015 /SC1

NT Vasistas Sisteminde Kullanılacak Aksesuarlar

Kod	Açıklama	Adet
259 717	Ç.A. İspanyoleti 15 mm 310-450 mm	1
259 718	451-620 mm	
259 719	621-800 mm	
259 720	801-1200 mm	
259 721	1201-1600 mm	
259 762	1601-2000 mm	
259 763	2001-2400 mm	
260 275	NT Köşe	1
255 224	Vasistas Makası	1
293 521	Arka Kilitleme	2
316 940	Standart Karşılık	5
264 015	Orta Menteşe	2



HATAU-Primat FL 190 Manuel alttan kumanda mekanizmaları

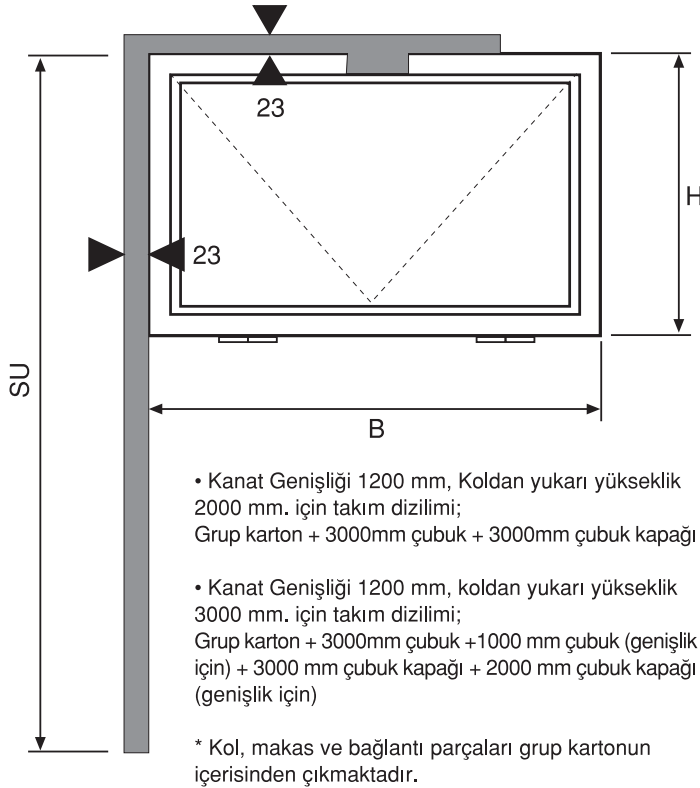

Grup Kartonlar

Kod	Açıklama	Koli Adedi
173002	Naturel	1
173005	Beyaz	1
170170	Eloksal Kahve	1

Çubuklar

Kod	Açıklama	Koli Adedi
108041	1000 mm	1
108050	3000 mm	1

Çubuk Kapakları

Kod	Açıklama	Koli Adedi
168869	Naturel 2000 mm	1
168839	Naturel 3000 mm	1
168872	Beyaz 2000 mm	1
168842	Beyaz 3000 mm	1
170143	Eloksal Kahve 2000 mm	1
170146	Eloksal Kahve 3000 mm	1

Basit Vasistas Sistemleri



Vasistas Makaslar

Kod	Açıklama	Koli Adedi
250.111.001	Vasistas Makas 130 mm	200
250.111.002	Vasistas Makas 200 mm	150
250.111.003	Güvenlikli Vasistas Makas	250
250.111.004	Vasistas Makas ALB.	250



Vasistas Makaslar

Kod	Açıklama	Adet
255.224	Vasistas Makası	1

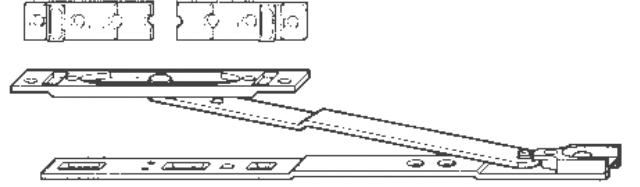

Ayarlı Çarpma Mandallar

Kod	Açıklama	Koli Adedi
250.106.001	Plastik	400
450.304.001	Alüminyum	50

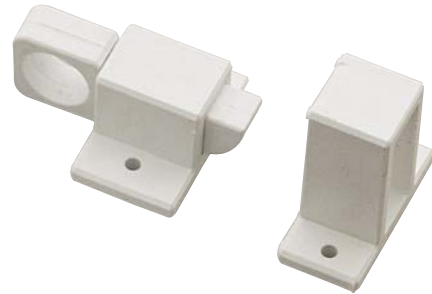



Alüminyum Pencere Kolları

Kod	Açıklama	Koli Adedi
990268	Baseline	20
2308 797	Secustik	20
8118 333	Basık Kol	20
227 868	Kilitli Kol	20
312 766	Sürme Gömme Kol	30

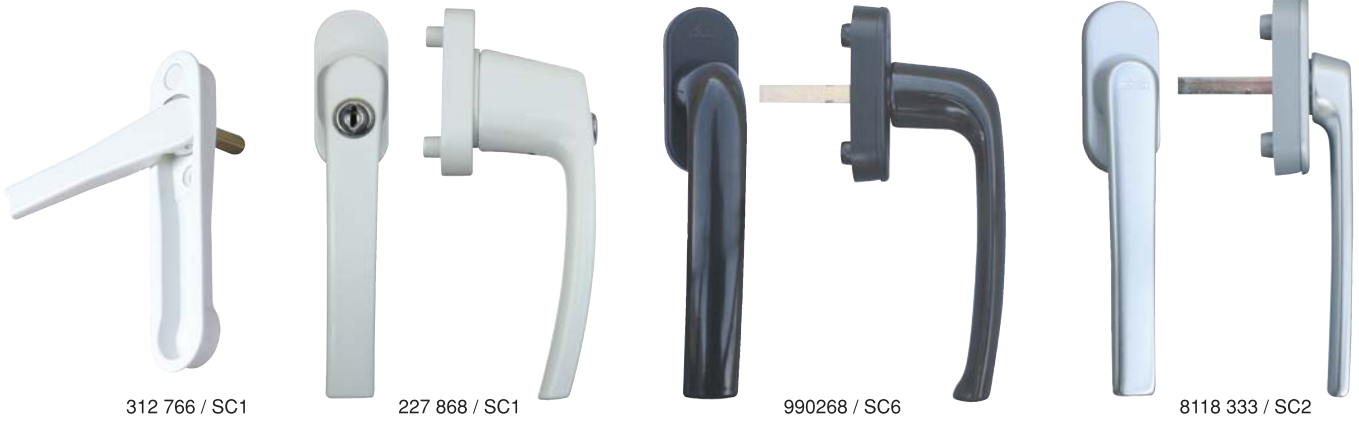

Kilitli Kapı Kolları

Kod	Açıklama	Koli Adedi
2035572	85 Eksen	6
1932838	92 Eksen	6
990231	Kilitli Balkon Kapı Kolu	6
228237	Rozetli Balkon Kapı Kolu	6



Pencere ve Kapı Kolları

HOPPE®
Handle of excellence.

Alüminyum Pencere Kolları

Kod	Açıklama	Koli Adedi
0960 U26-2191490	Bogoto	20
8127672	Tokyo	20
8156507	Tokyo Kilitli Kol	20

				
Beyaz SC1	Gümüş SC2	Şampanya SC3	Altın SC4	Koyu Kahve SC6



0960 U26-2191490 / SC1



8156507 / SC6



8127672 / SC3

HOPPE®
Handle of excellence.

Kilitli Kapı Kolları

Kod	Açıklama	Koli Adedi
2035572	82 Eksen	6
1932838	92 Eksen	6

				
Beyaz SC1	Gümüş SC2	Şampanya SC3	Altın SC4	Koyu Kahve SC6

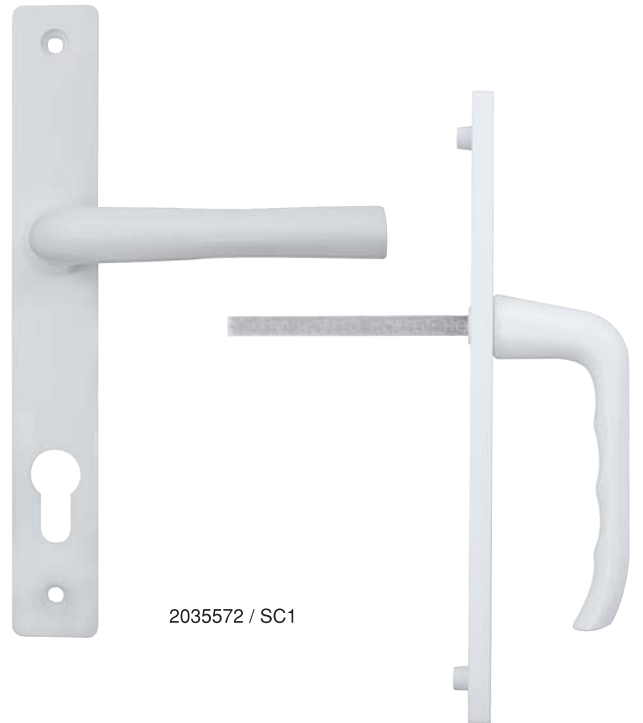

2035572 / SC1



Alüminyum Pencere Kolu

Kod	Açıklama	Koli Adedi
240.002.001	Pencere Kolu 35 mm	100
240.002.002	Pencere Kolu 40 mm	100



Pencere kolu



Alüminyum Kapı Kolları

Kod	Açıklama	Koli Adedi
244.001.001	Yaylı Silindir Kapı kolu 85/28	40
244.001.002	Yaylı Silindir Kapı kolu 85/35	40
244.001.003	Yaylı Silindir Kapı kolu 92/28	40
244.001.004	Yaylı Silindir Kapı kolu 92/35	40
244.002.001	Yaylı Oda Kapı kolu 90/28	40
244.002.002	Yaylı Oda Kapı kolu 90/35	40
244.003.001	Yaylı WC Kapı kolu 90/28	40
244.003.002	Yaylı WC Kapı kolu 90/35	40
460.104.001	D Kol	100
249.001.001	C Kol	100



Yaylı Silindir Kapı kolu



Yaylı WC Kapı kolu



Yaylı Oda Kapı kolu



D Kol



C Kol

Kilitler ve Bareller



PVC Kapılar için Silindirli Gömme Kilitler

Kod	Açıklama	Koli Adedi
153-P /35	Dar	30
152-RP/40	Geniş - Rulmanlı	30

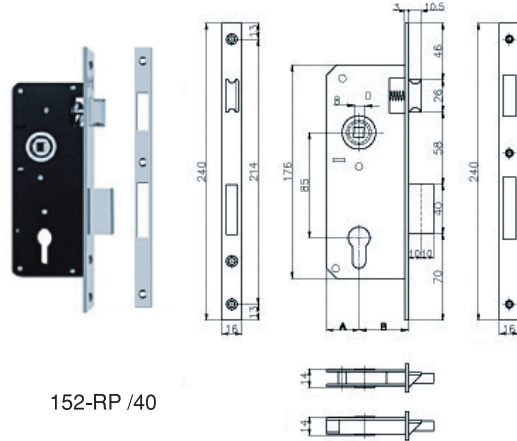
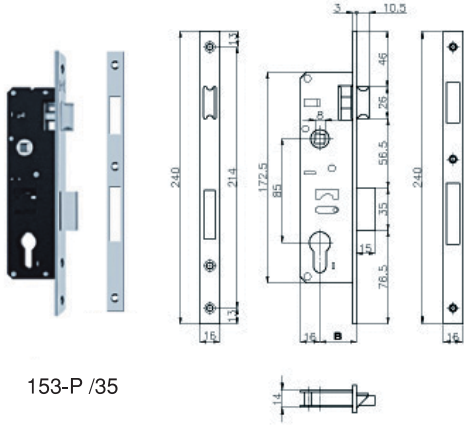

PVC İç Kapı Gömme Kilitler

Kod	Açıklama	Koli Adedi
269 P WC/35	Dar - Banyo	40
269 RP WC/40	Ekstra Rulmanlı - Banyo	40
266 P 35	Dar - Oda	40
151 RP-40	Ekstra Rulmanlı - Oda	40

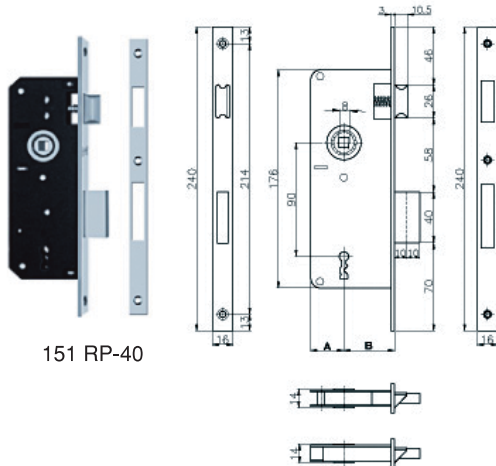
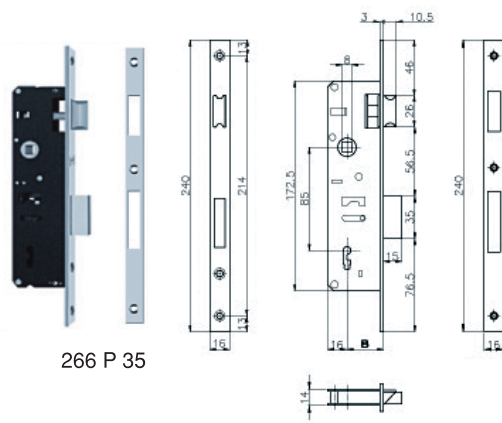
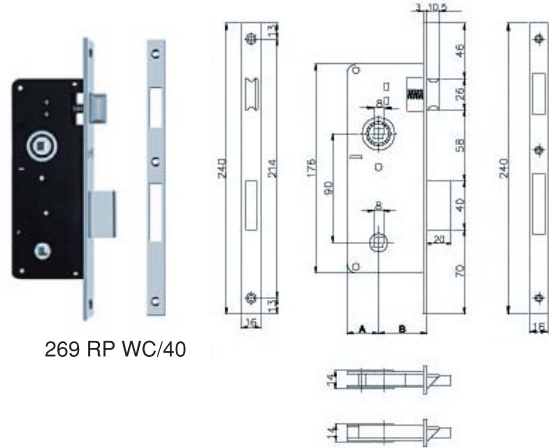
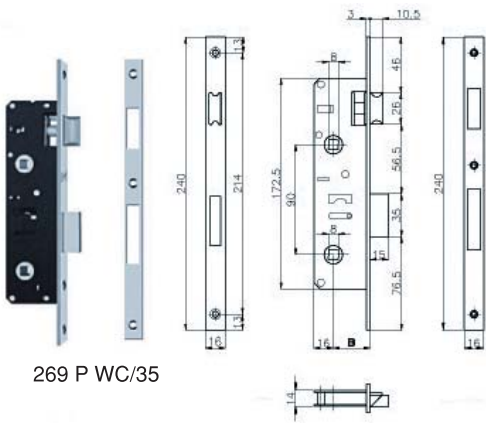



Bareller

Kod	Açıklama	Koli Adedi
349609	40x50 90'lık Krom Nikel	24
349607	40x50 80'lık Krom Nikel	24
450977	Topuzlu Silindir	24



349609



450977



Bareller

Kod	Açıklama	Koli Adedi
206	40x50 90'lık Krom Nikel	36



Bareller

Kod	Açıklama	Koli Adedi
164 BM	Mandallı Silindir	12
164 BT	Topuzlu silindir	12



164 BM



164 BT

Bağlantı Elemanları ve Karşılıkları



Bağlantı Elemanları

Kod	Açıklama	Koli Adedi
002.001	LINE70	125
002.002	LINE60 / ECOLINE60	200
002.003	ECOLINE60 Gizli Bağlantı	300
002.004	LINE60 Gizli Bağlantı	250
002.005	LINE70 Gizli Bağlantı	250
002.006	LINEX 60/70 Gizli Bağlantı	200
002.007	LINE80 Bağlantı	200

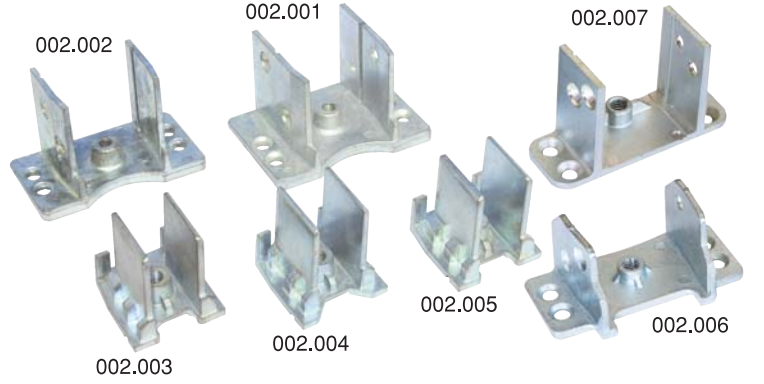

Karşılıklar

Kod	Açıklama	Koli Adedi
007.001	Schönline İspanyolet Karşılığı	1.000
007.004	Schönline Binili Kanat Karşılığı	1.000
316940	Roto İspanyolet Karşılığı	100
316942	Roto Güvenlikli Karşılık	100

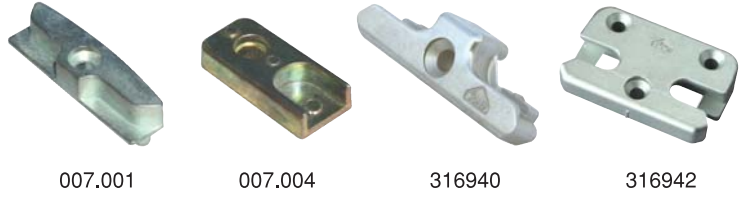

Kapı ve Pencere Sürgüleri

Kod	Açıklama	Koli Adedi
120.022.007	Çelik Sürgü ve Karşılığı	20
120.022.014	Binili Kanat Sürgü ve Karşılığı	20

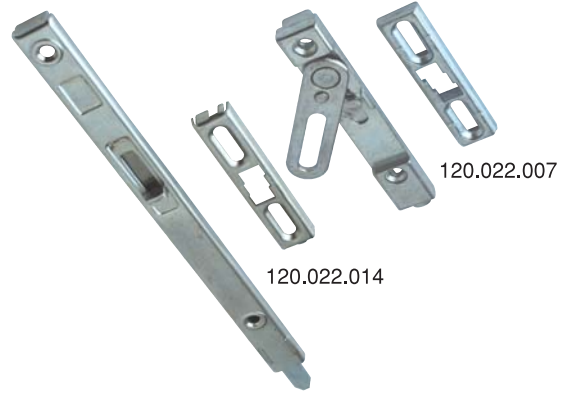

Kapı Kilit Karşılıkları

Kod	Açıklama	Koli Adedi
007.003	Ayarlı Kilit Karşılığı Uzun	100
007.002	Ayarlı Kilit Karşılığı Kısa	200

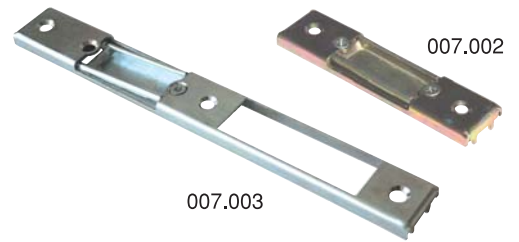

Balkon Kapı Tutucuları

Kod	Açıklama	Koli Adedi
007.010	Balkon Tutucu Çırtıt	150



Balkon Kapı Tutucuları

Kod	Açıklama	Koli Adedi
120.022.006	Balkon Tutucu Çırtıt	150



Sürme İspanyoletler

Kod	Ölçü	Koli Adedi
329 051	400 - 600 mm	10
329 052	600 - 800 mm	10
329 053	800 - 1000 mm	10
336 620	1000 - 1200 mm	10
328 974	1200 - 1800 mm	10
328 994	1200 - 1800 mm Kilitli	10

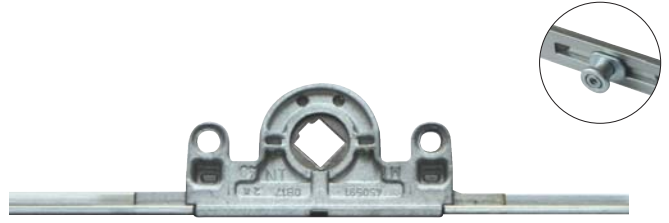

Sürme İspanyoletler

Kod	Ölçü	Koli Adedi
Zamak 15 mm		
110.060.315.100	600-800 mm	50
110.080.315.100	800-1000 mm	50
110.100.315.100	1000-1200 mm	50
110.120.315.100	1200-1400 mm	50
110.140.315.100	1400-1600 mm	25
110.160.315.100	1600-1800 mm	25
110.180.315.100	1800-2000 mm	25
110.200.315.100	2000-2200 mm	25



Kod	Ölçü	Koli Adedi
Sac 15 mm		
115.060.315.100	600-800 mm	50
115.080.315.100	800-1000 mm	50
115.100.315.100	1000-1200 mm	50
115.120.315.100	1200-1400 mm	50
115.140.315.100	1400-1600 mm	25
115.160.315.100	1600-1800 mm	25
115.180.315.100	1800-2000 mm	25
115.200.315.100	2000-2200 mm	25



Sürme Kollar

Kod	Açıklama	Koli Adedi
003.007	Gömme Tutamak	20
312.766	Sürme gömme kol	30
003.017	Çekme Kol	10

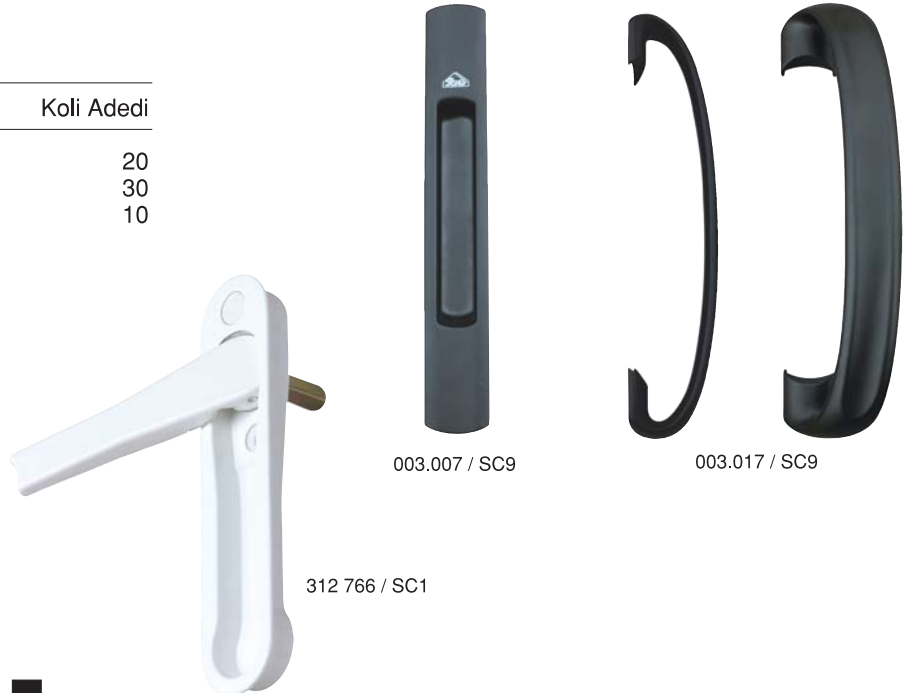

					
Beyaz SC1	Gümüş SC2	Şampanya SC3	Altın SC4	Koyu Kahve SC6	Siyah SC9

Sürme Aksesuarları



Paralel Sürme Kollar

Kod	Açıklama	Koli Adedi
003.018	Tam Otomatik	20
003.017	Yarı Otomatik	20



Beyaz
SC1



Koyu Kahve
SC6



Basit Sürme Tekerleri

Kod	Açıklama	Koli Adedi
280445	Ayarlı	10



Basit Sürme Tekerleri

Kod	Açıklama	Koli Adedi
013.012	Ayarlı	10



Sürme Karşılıklar

Kod	Açıklama	Koli Adedi
007.005	Zamak	500
007.006	Sac	1,500

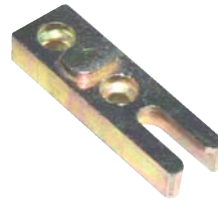

007.005



007.006



Sürme Fitiller

Kod	Açıklama	Koli Adedi
013.005	Interlock	900 m
013.002	Kanat	500 m

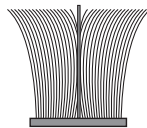
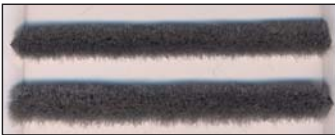

Sürme Kanat Altı Takozu

Kod	Açıklama	Koli Adedi
013.004	Sürme Kanat Altı Takozu	25

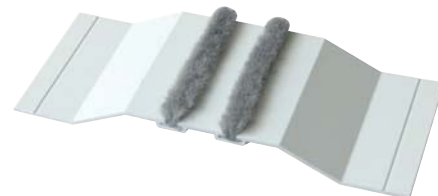



130 S Yarı Otomatik (130 Kg Taşıma Kapasiteli)

BOY	EN	600-800 mm	801-900 mm	901-1000 mm	1001-1050 mm	1051-1200 mm	1201-1250 mm	1251-1400 mm	1401-1450 mm	1451-1650 mm
		KOD	KOD	KOD	KOD	KOD	KOD	KOD	KOD	KOD
800-1000 mm		S-548	S-556	S-564	S-572	019.580	S-588	S-596	019.604	019.612
1001-1200 mm		S-549	S-557	S-565	S-573	019.581	S-589	S-597	019.605	019.613
1201-1400 mm		S-550	S-558	S-566	S-574	019.582	S-590	S-598	019.606	019.614
1401-1600 mm		S-551	S-559	S-567	S-575	019.583	S-591	S-599	019.607	019.615
1601-1800 mm		S-552	S-560	S-568	S-576	019.584	S-592	S-600	019.608	019.616
1801-2000 mm		S-553	S-561	S-569	S-577	019.585	S-593	S-601	019.609	019.617
2001-2200 mm		S-554	S-562	S-570	S-578	019.586	S-594	S-602	019.610	019.618
2201-2400 mm		S-555	S-563	S-571	S-579	019.587	S-595	S-603	019.611	019.619

150 Z Tam Otomatik (150 Kg Taşıma Kapasiteli)

BOY	EN	720-900 mm	901-1050 mm	1051-1250 mm	1251-1450 mm	1451-1650 mm
		KOD	KOD	KOD	KOD	KOD
900-1200 mm		Z-620	Z-624	Z-628	Z-632	Z-636
1201-1600 mm		Z-621	Z-625	Z-629	Z-633	Z-637
1601-2000 mm		Z-622	Z-626	Z-630	Z-634	Z-638
2001-2400 mm		Z-623	Z-627	Z-631	Z-635	Z-639

180 Z Tam Otomatik (180 Kg Taşıma Kapasiteli)

BOY	EN	720-900 mm	901-1050 mm	1051-1250 mm	1251-1450 mm	1451-1650 mm	1651-1850 mm	1851-2000 mm
		KOD	KOD	KOD	KOD	KOD	KOD	KOD
900-1200 mm		Z-640	Z-644	Z-648	Z-652	Z-656	Z-660	Z-664
1201-1600 mm		Z-641	Z-645	Z-649	Z-653	Z-657	Z-661	Z-665
1601-2000 mm		Z-642	Z-646	Z-650	Z-654	Z-658	Z-662	Z-666
2001-2400 mm		Z-643	Z-647	Z-651	Z-655	Z-659	Z-663	Z-667



Tam Otomatik Paralel Sürme Sistemi

Roto 150 NT / 180 NT

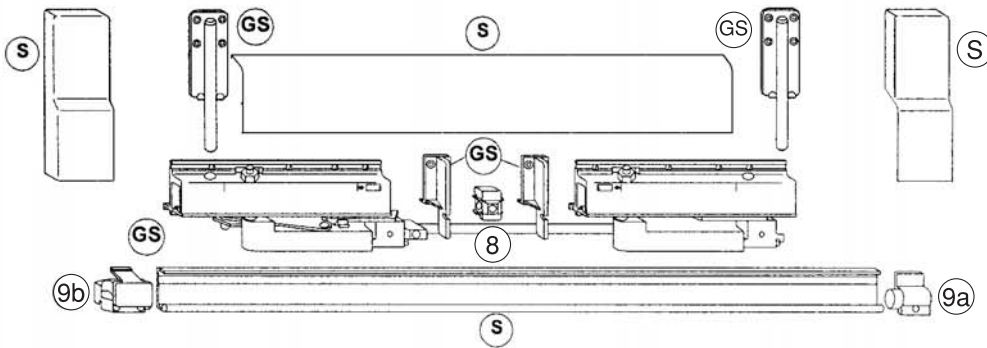
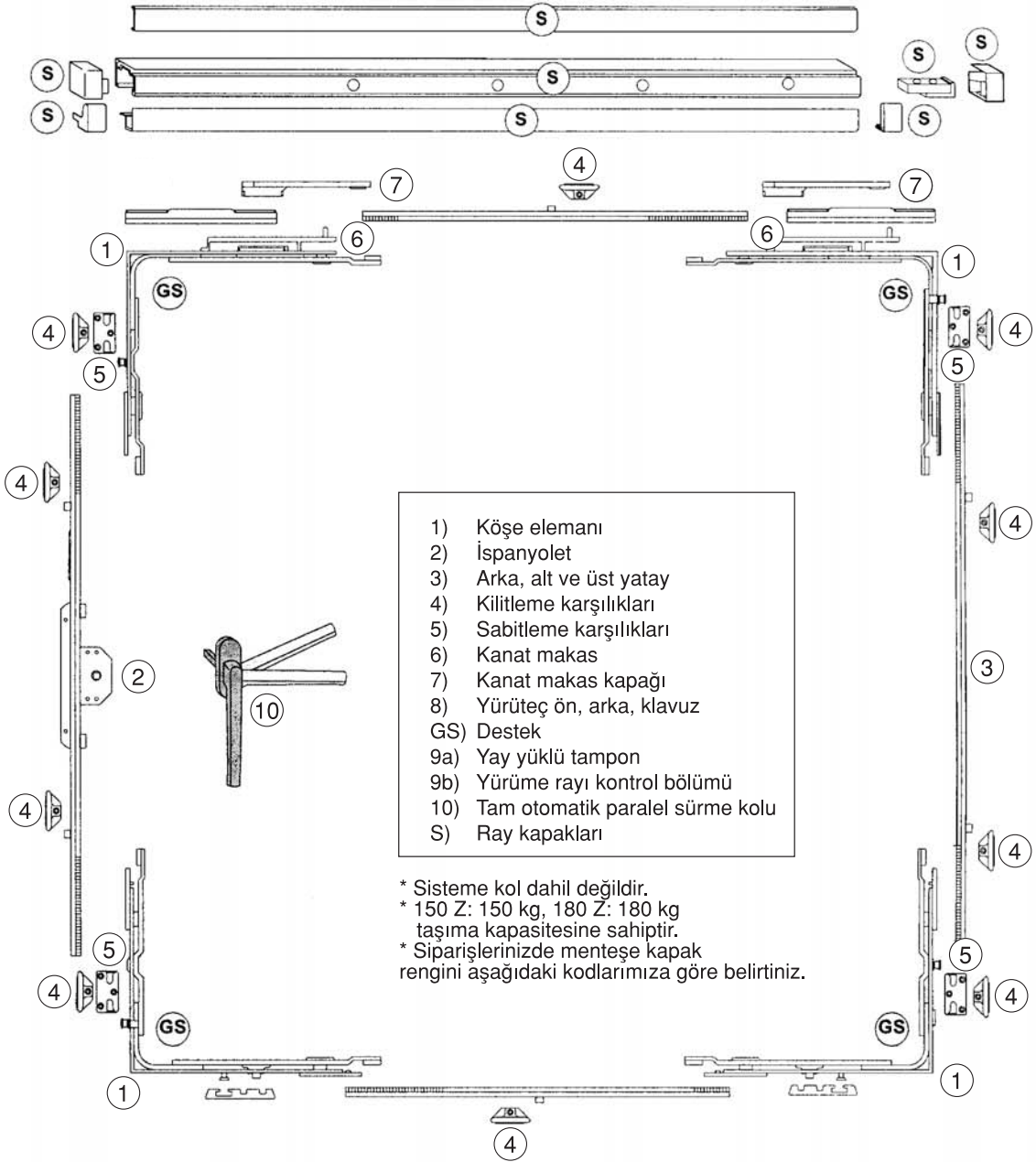

Kapak Renkleri

				
Beyaz SC1	Gümüş SC2	Şampanya SC3	Altın SC4	Koyu Kahve SC6

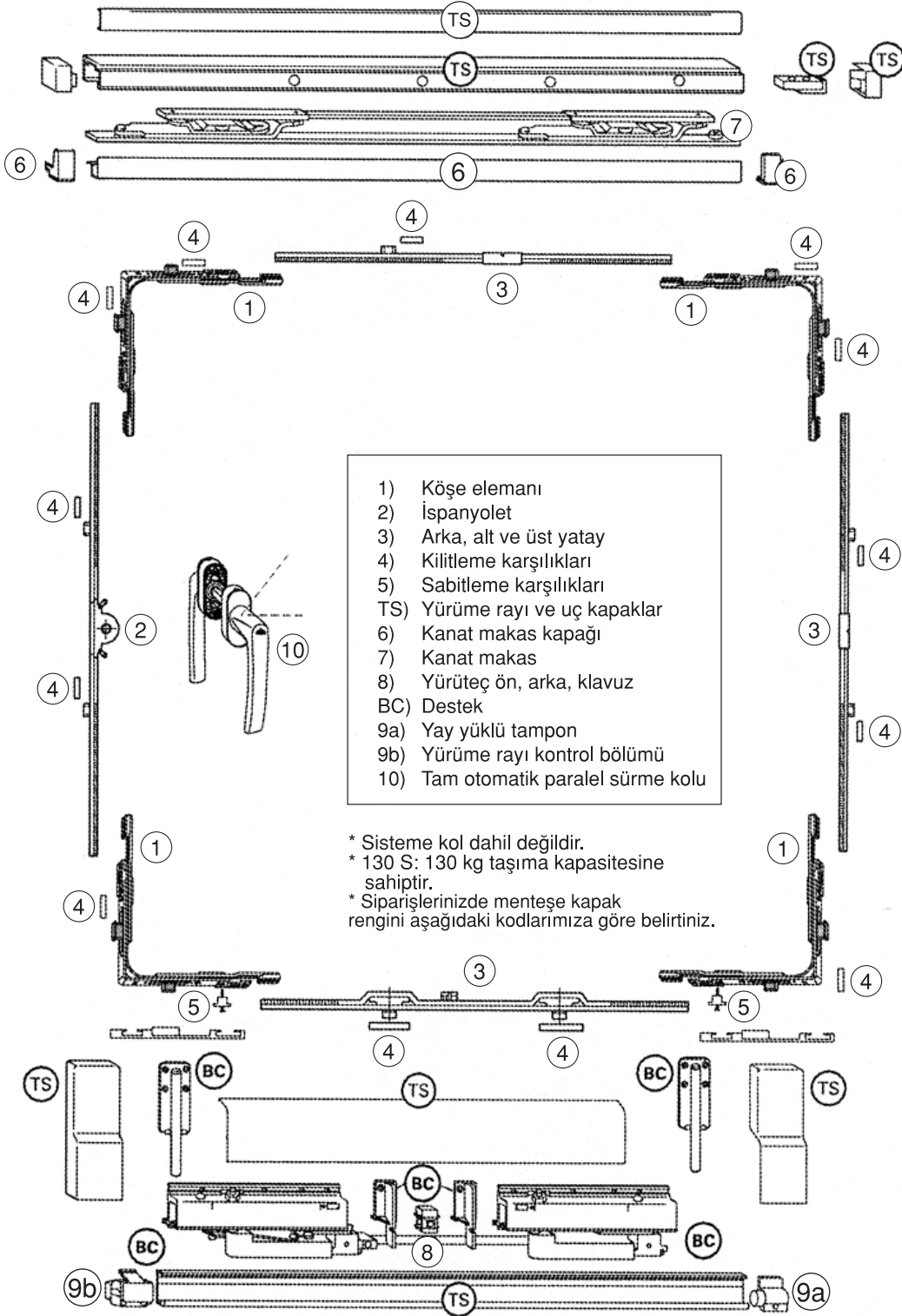

Kapak Renkleri

Beyaz SC1	Gümüş SC2	Şampanya SC3	Altın SC4	Koyu Kahve SC6

Paralel Sürme Sistemleri (Manuel)

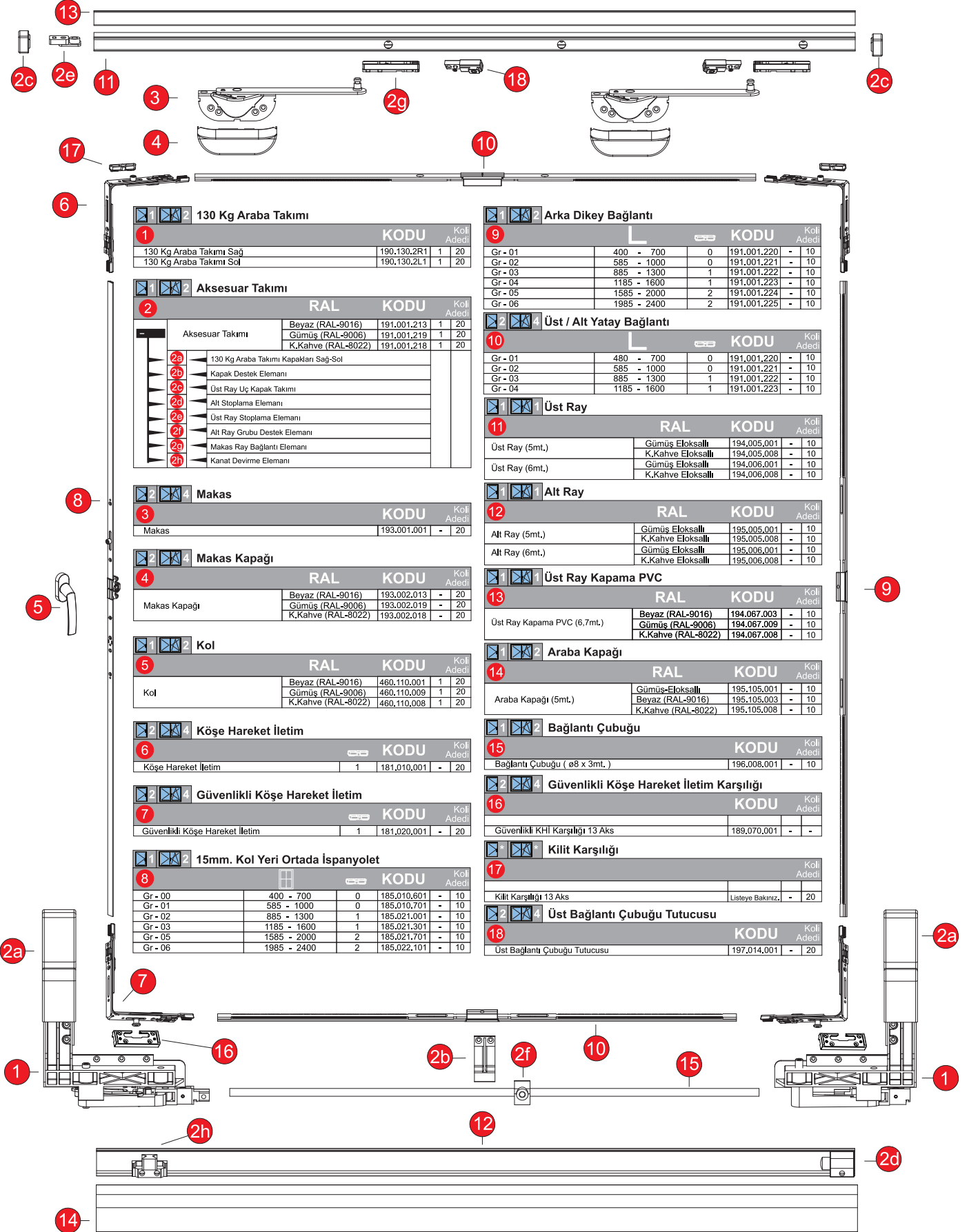

☒ : Tek Kanat Pencere ☒ : Çift Kanat Pencere

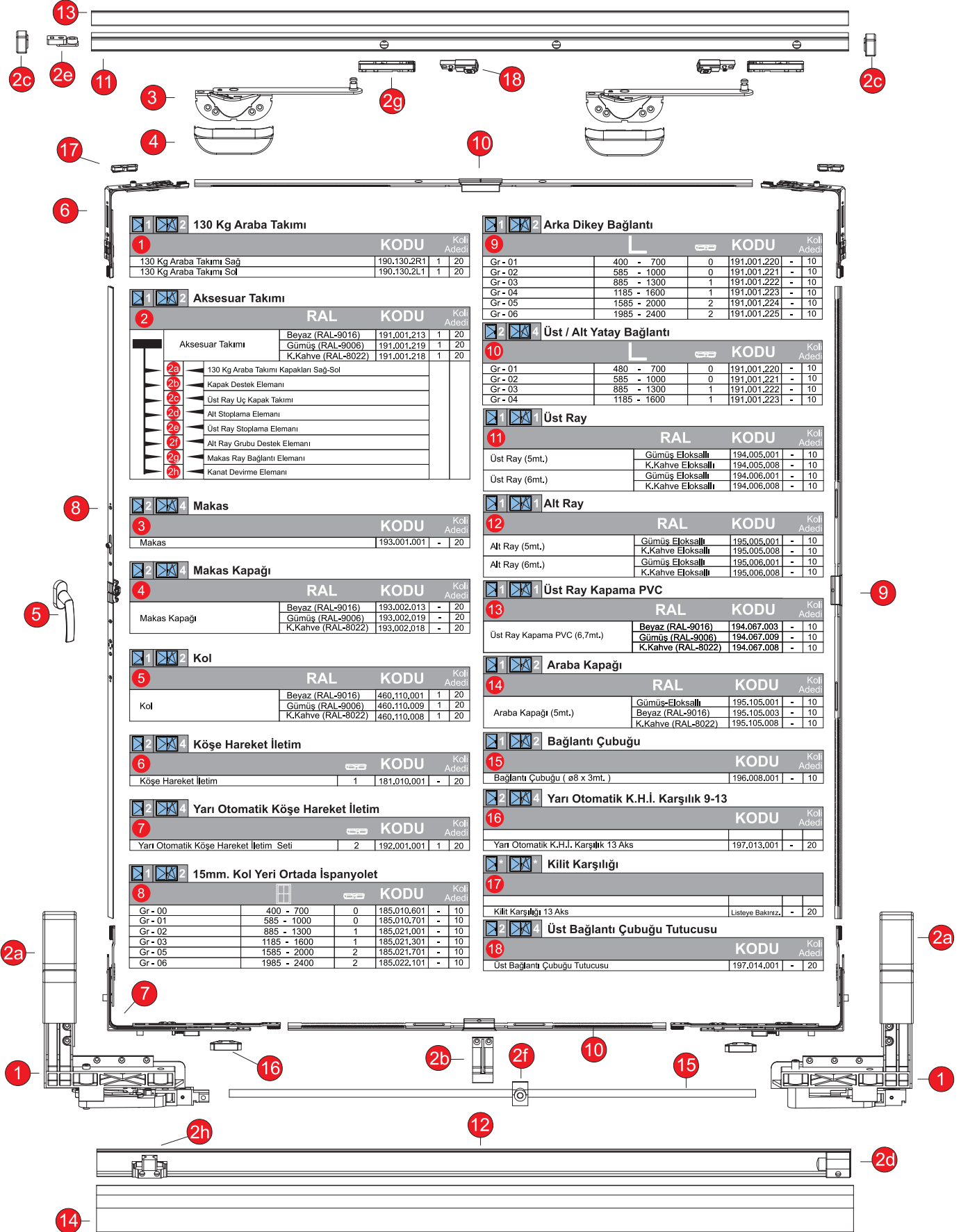

☒ : Tek Kanat Pencere ☒ : Çift Kanat Pencere

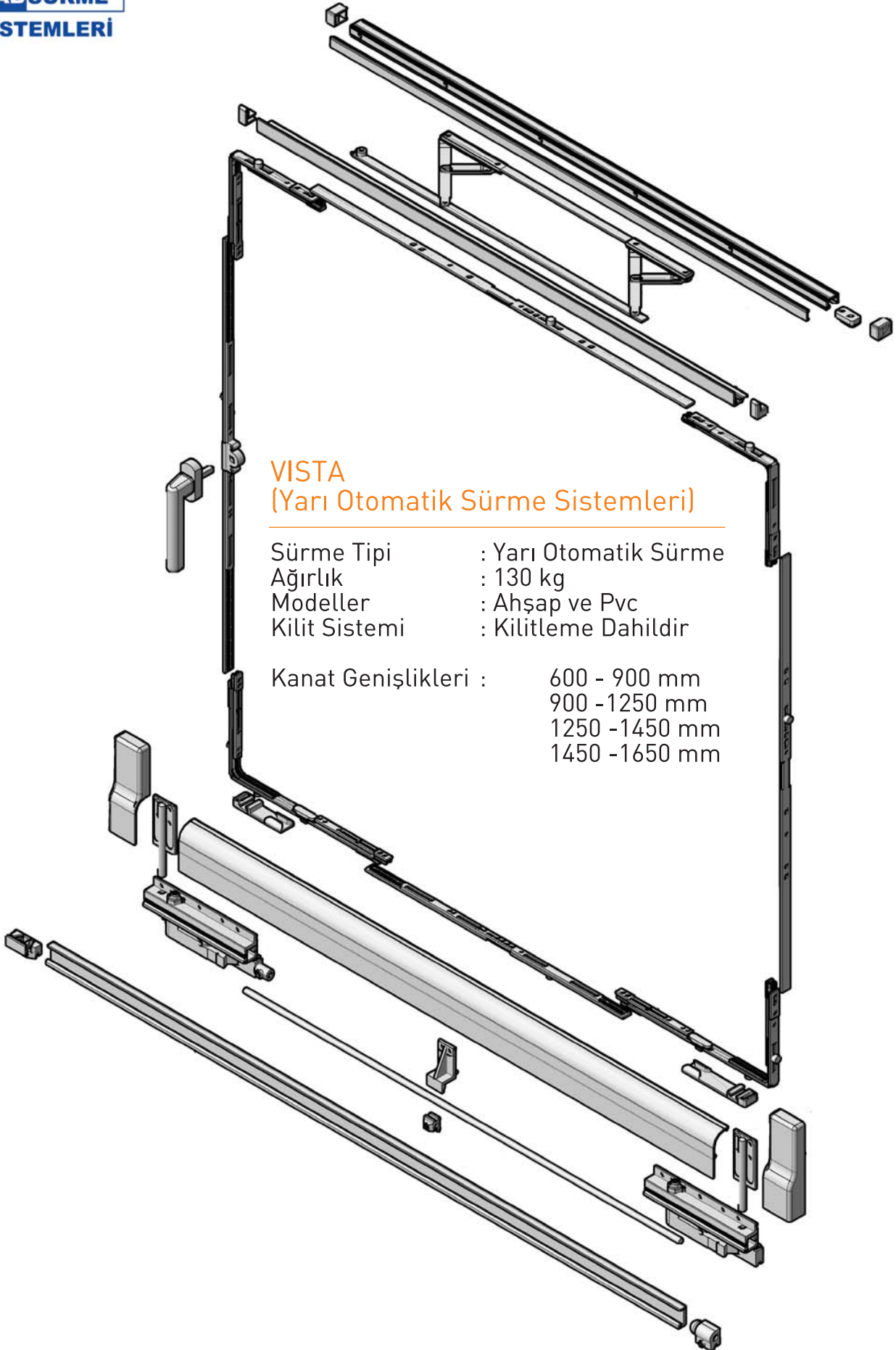

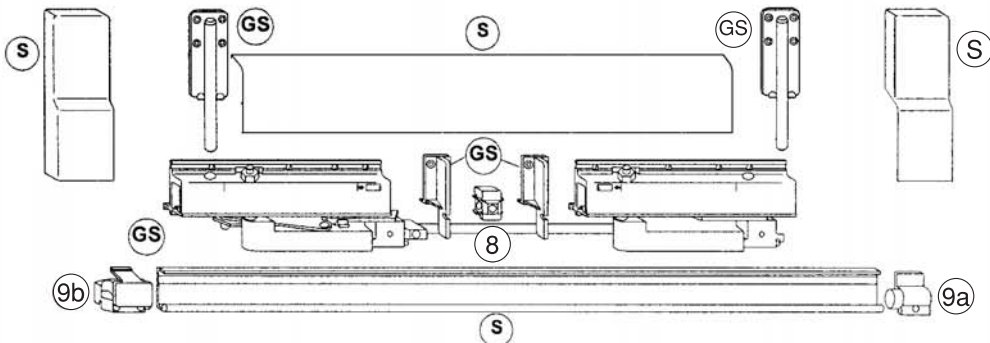
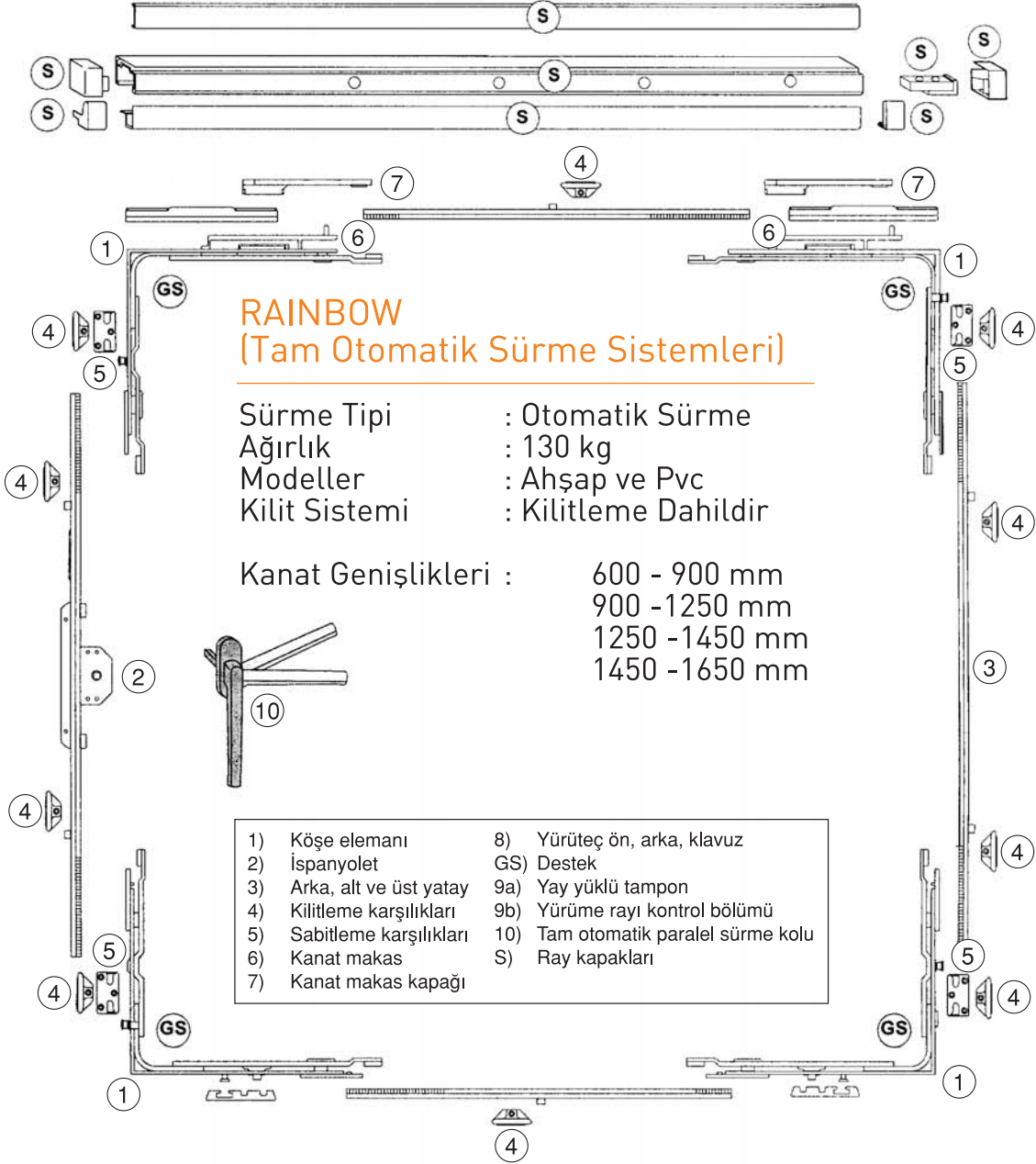

Vidalar



Resimde 010.018 kodlu 4.8X60 gösterilmiştir.

YSB Matkap Uçlu Vidalar

Kod	Ölçüsü	Koli Adeti
010.019	3.9X13	15.000
010.001	3.9X16	15.000
010.020	3.9X19	15.000
010.021	4.8X16	13.000
010.022	4.8X19	10.000
010.023	4.8X32	8.000
010.024	4.8X32	5.000
010.025	4.8X38	5.000
010.026	4.8X50	3.000
010.018	4.8X60	3.000
010.027	4.8X70	2.000
010.028	4.8X80	1.500



Resimde 010.041 kodlu 4.8X60 gösterilmiştir.

YHB Matkap Uçlu Vidalar

Kod	Ölçüsü	Koli Adeti
010.029	3.9X13	15.000
010.002	3.9X16	15.000
010.030	3.9X19	15.000
010.031	3.9X22	12.000
010.032	3.9X25	11.000
010.033	3.9X32	10.000
010.034	3.9X38	8.000
010.035	4.2X19	15.000
010.036	4.2X22	10.000
010.003	4.2X25	10.000
010.013	4.2X32	8.000
010.005	4.2X38	6.000
VIV16	4.2X38 EJOT	5.000
010.037	4.2X45	5.000
010.038	4.8X25	5.000
010.039	4.8X32	5.000
010.040	4.8X50	4.000
010.041	4.8X60	3.000
010.042	4.8X70	2.000
010.043	4.8X80	1.500



Resimde 010.054 kodlu 4.2X45 YHB HI-LO gösterilmiştir.

Seyrek Dişli Vidalar

Kod	Ölçüsü	Koli Adeti
010.014	3.9X22 YHB	15.000
010.044	3.9X25 YHB	12.000
010.045	3.9X32 YHB	10.000
010.046	3.9X38 YHB	8.000
010.047	4.2X32 YHB	8.000
010.012	4.2X38 YHB	6.000
010.048	4.2X45 YHB	5.000
010.049	4.8X50 YHB	4.000
010.006	3.9X22 YHB HI-LO	15.000
010.050	3.9X25 YHB HI-LO	12.000
010.051	3.9X32 YHB HI-LO	10.000
010.052	3.9X38 YHB HI-LO	8.000
010.053	4.2X32 YHB HI-LO	8.000
010.004	4.2X38 YHB HI-LO	6.000
010.054	4.2X45 YHB HI-LO	5.000



Resimde 010.059 kodlu 60X80 YHB gösterilmiştir.

Montaj Vidaları

Kod	Ölçüsü	Koli Adeti
010.007	M6X60 YSB	1.500
010.055	4.8X50 YSB	4.000
010.056	4.6X60 YSB	3.000
010.057	60X80 YSB	1.200
010.058	60X100 YSB	1.000
010.059	60X80 YHB	1.200
010.060	60X100 YHB	1.000



Resimde 010.008 kodlu 7.5X60 gösterilmiştir.

Buldex Vidalar

Kod	Ölçüsü	Koli Adeti
010.008	7.5X60	1.500
010.009	7.5X80	1.000
010.010	7.5X100	1.000
010.011	7.5X120	750
010.061	7.5X150	750
010.062	7.5X180	400



Resimde 011.001 kodlu M10X60 gösterilmiştir.

Çelik Dübeller

Kod	Ölçüsü	Koli Adeti
011.001	M10X60	1.000
011.002	M10X80	1.000
011.003	M10X100	1.000
011.004	M10X120	1.000

SCHÖNLINE TPV

Kod	Açıklama	M
11700001	Kasa Contası - Gri	1.000
11700002	Kasa Contası - Siyah	1.000
11700003	Kanat Contası - Gri	1.000
11700004	Kanat Contası - Siyah	1.000
008.002	Kanal Kapama Contası	1.000
21800008	Yaprak Conta - Gri	1.000
21800009	Yaprak Conta - Siyah	1.000



11700001



11700003



008.002



21800008

SCHÖNLINE EPDM

Kod	Açıklama	Koli Miktarı
008.005	Eşik İçin Özel Conta 1	12 Kg
008.006	Eşik İçin Özel Conta 2	12 Kg
008.007	Eşik İçin Özel Conta 3	12 Kg
1140	Çam Contası	12 Kg
1102	Kanat Contası	12 Kg



008.007



008.005



008.006



1140



1102

SCHÖNLINE Destek Sacları

Kod	Açıklama
009.001	Kasa-Kanat-Ortakayıt Destek Sacı
009.002	Kapı Destek Sacı (28x67)
009.003	Kapı Destek Sacı (28x50)
009.004	Sürme Kasa Destek Sacı
009.005	Griyaj Profili Destek Sacı (30x60)
009.006	60'lık Yükseltme / Kutu Profili Destek Sacı
009.007	LINE80 Kanat Profili Destek Sacı
009.008	LINE80 Ortakayıt Profili Destek Sacı
009.009	LINE80 Kanat Adaptör Profili Destek Sacı
009.010	Dar Kasa Profili Destek Sacı

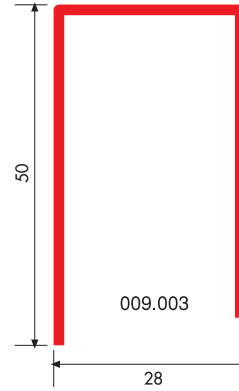
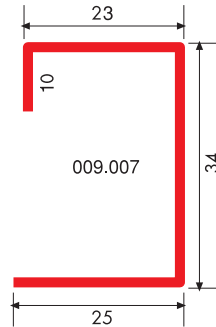
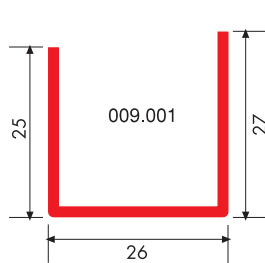
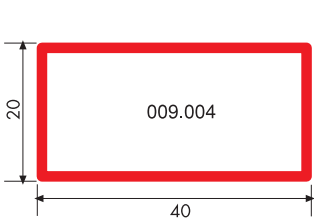

009.003

50

28

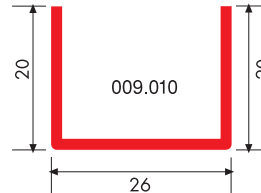

009.010

20

26

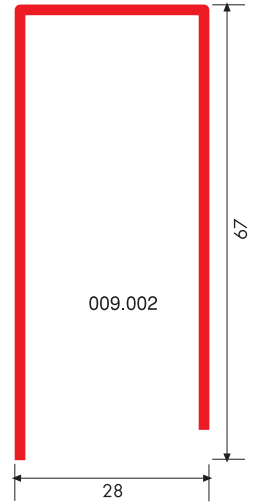

009.002

67

28

a: 1 mm
b: 1.2 mm
c: 1.5 mm
d: 2 mm

* Siparişlerinizde yukarıdaki kodları (a-b-c-d) ekleyerek, destek sacı kalınlığını belirtiniz.

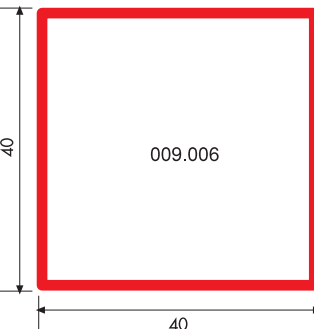

009.006

40

40

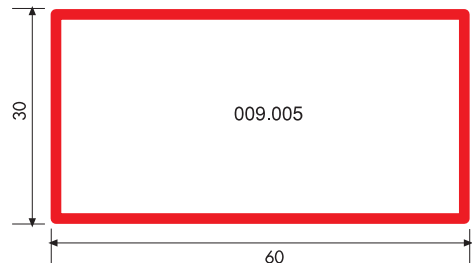

009.005

30

60

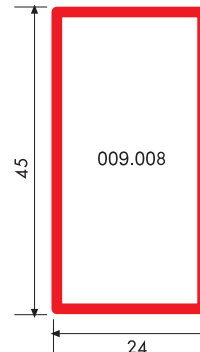

009.008

45

24

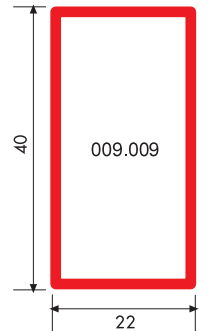

009.009

40

22

Plastik Malzemeler

Kanat Adaptör Kapağı

Kod	Açıklama	Koli Adedi
012.006	LINE70	50
012.007	LINE60 / ECOLINE60	50
012.378	LINEX60 / LINEX70	50



Kapı Köşe Kaynak Takviye Takozu

Kod	Açıklama	Koli Adedi
012.064	Kapı Köşe Kaynak Takviye Takozu	250



Eşik Adaptörü

Kod	Açıklama	Koli Adedi
012.122	LINE 60	50
012.123	LINE 70	50

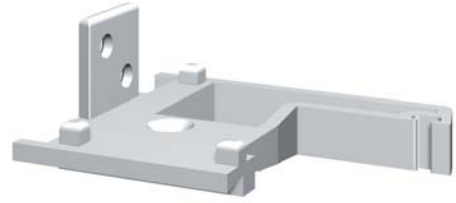

Ayarlı Cam Takozu

Kod	Açıklama	Koli Adedi
012.070	24 mm Ayarlı Cam Takozu	200
012.148	32 mm Ayarlı Cam Takozu	200



Cam Takozu Yükseltme

Kod	Açıklama	Koli Adedi
012.121	Cam Takozu Yükseltme	200



Plastik Parçalar

Kod	Açıklama	Koli Adedi
012.004	Su Tahliye Tapası	5.000
012.005	Montaj Tapası	5.000
012.123	Kanat Kaldırma Takozu	1.000

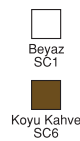

Kapı Altı Süpürgelik

Kod	Açıklama	M
012.238	Kapı Altı Süpürgelik	mt



Denizlik Kapağı

Kod	Açıklama	Koli Adedi
012.170	20 cm	50
012.187	25 cm	50

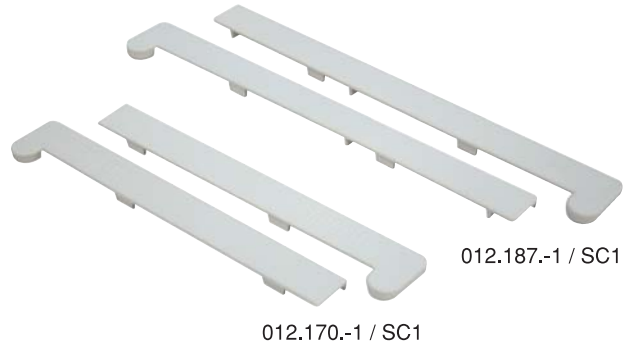

Pervazmatik

Kod	Açıklama	Koli Adedi
012.151	Pervazmatik	50

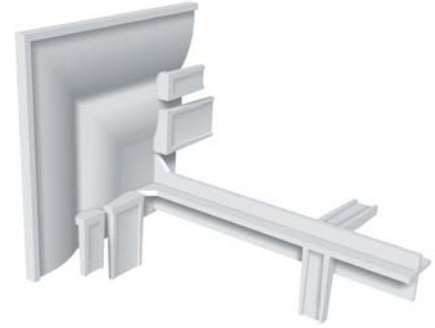

Cam Takozları

Kod	Açıklama	Koli Adedi
012.002	Kademeli	10.000
012.003	İnce	10.000

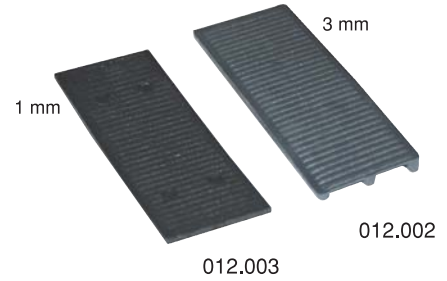

İnterlock Kapama

Kod	Açıklama	Koli Adedi
012.029-1	Beyaz	50



İnterlock El Presi

Kod	Açıklama	Koli Adedi
012.232	İnterlock El Presi	1



Sineklik Aksesuarları

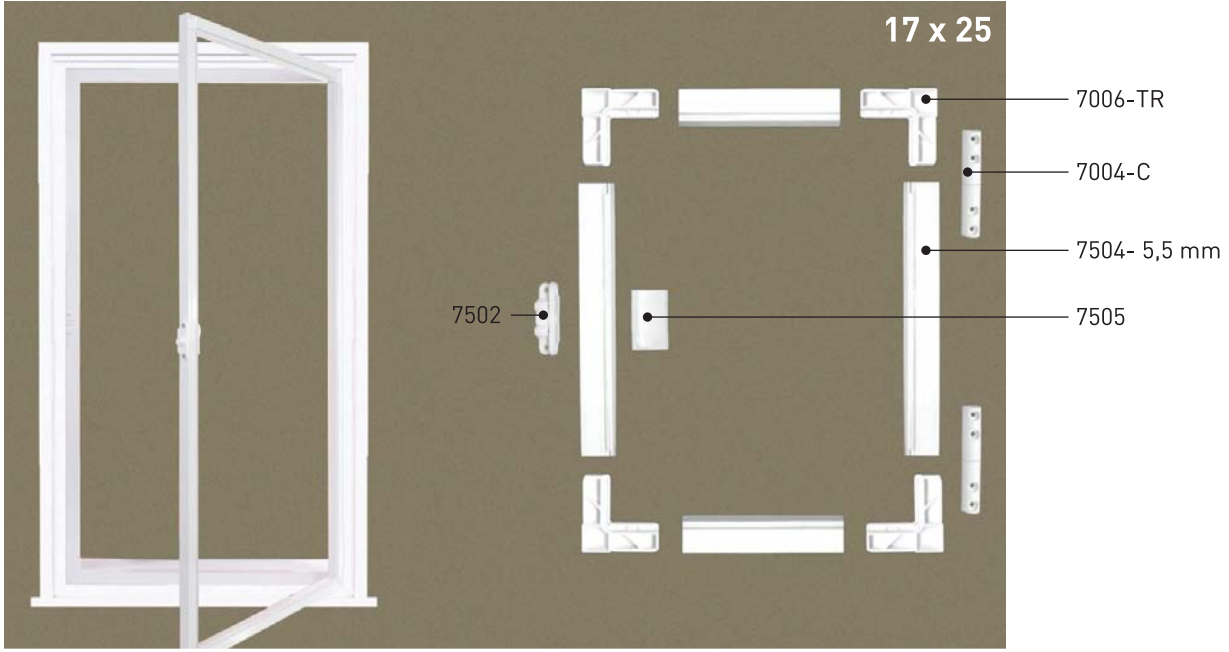

Menteşeli Sineklik Pencere



Kod	Açıklama	Paket	Koli Adedi
7006-TR	Köşe	100	600
7004-C	Menteşe	100	1500
7504	5,5 mm Kordon	100	1000
7502	Plastik Kilit	100	2000
7505	Kol	100	2000

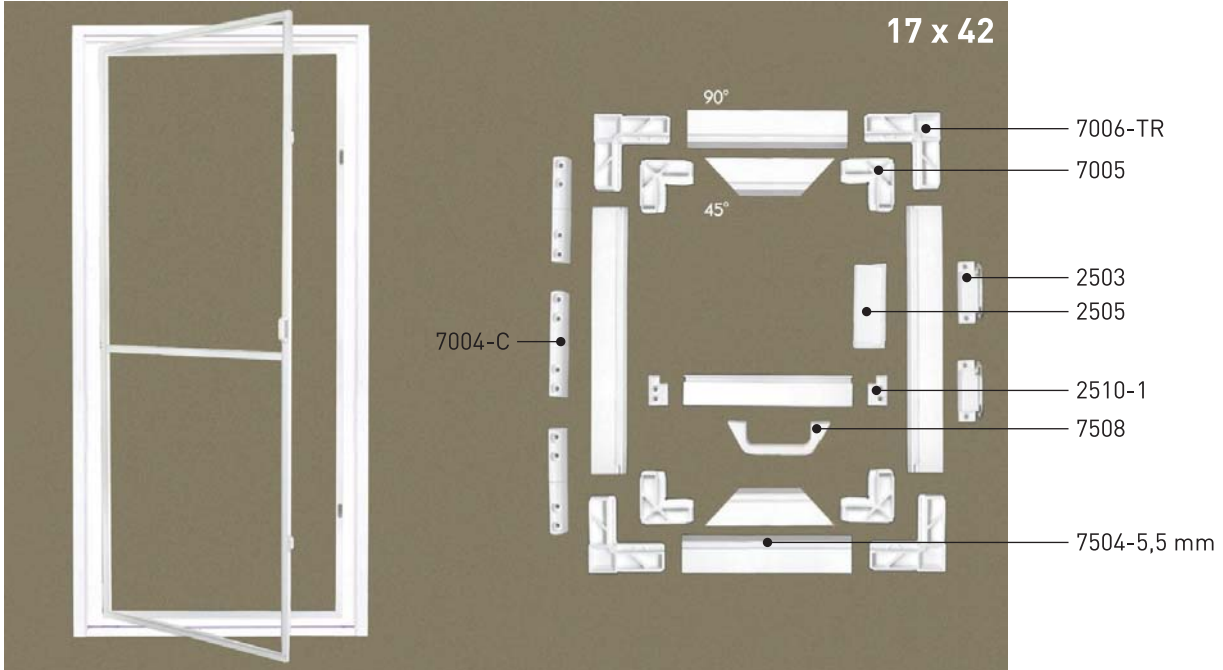

Menteşeli Sineklik Kapı



Kod	Açıklama	Paket	Koli Adedi
7005	Köşe	100	600
7004-C	Menteşe	100	1500
2503	Manyetik Kilit	30	900
2505	Kol	100	1500
2510-1	Ortakayıt	100	5000
7508	D Kol	60	900
7504	5,5 mm Kordon	100	1000
7006-TR	Köşe	100	600

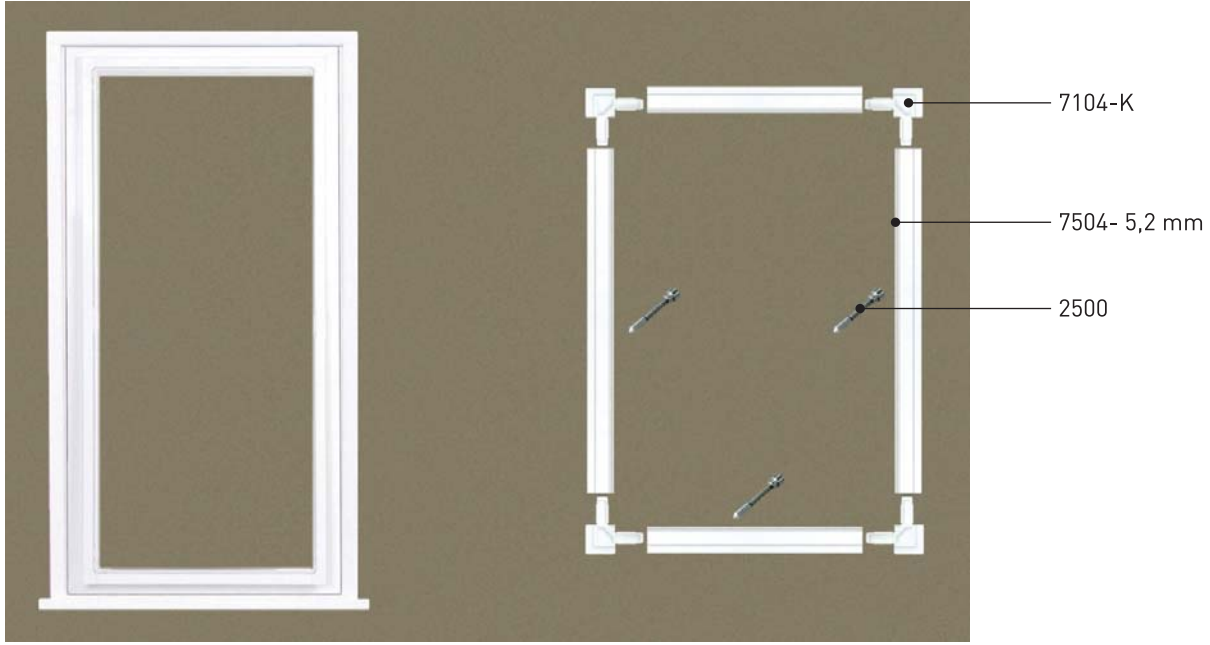

Sabit Sineklik Pencere



Kod	Açıklama	Paket	Koli Adedi
7104-K	Köşe	100	1500
7504	5,5 mm Kordon	100	1000
3500	Yaylı kilitleme		

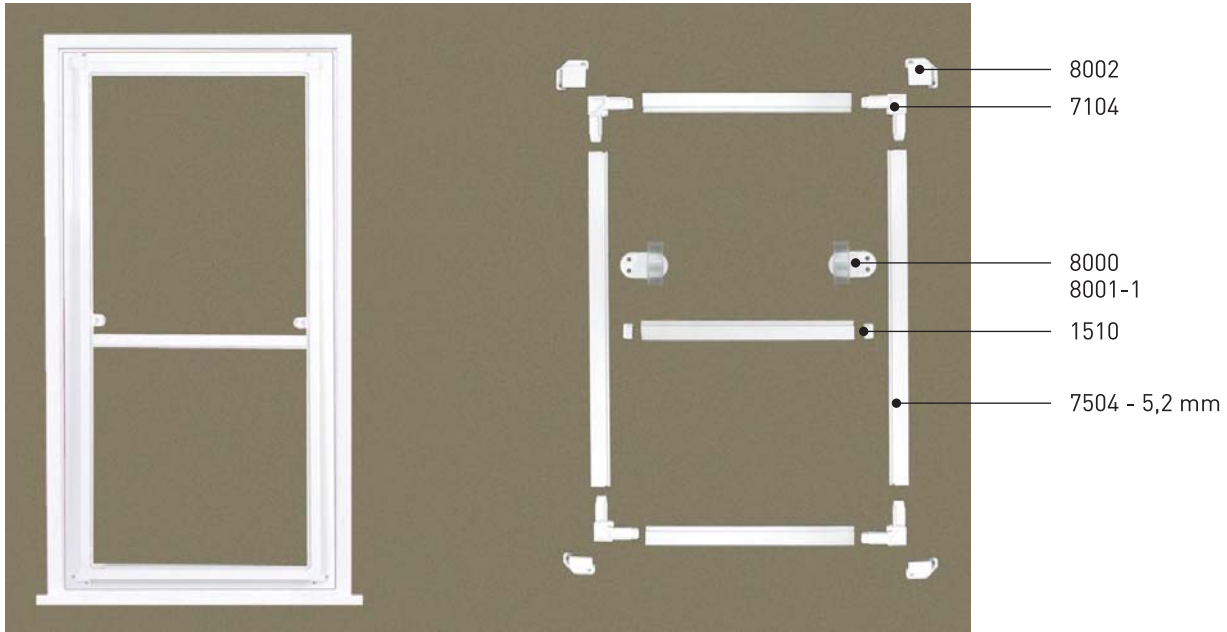

Sabit Sineklik Pencere



Kod	Açıklama	Paket	Koli Adedi
8002	Pabuç	25	500
7104	Köşe	100	1500
8001-1	Kol	100	2500
8000	Kol	100	2500
7504	5,2 mm Kordon	100	1000



TUBA (Sürme)



C Kol (Alüminyum)



Kol



Kordon



Rulman (Pirinç)



Köşe (Alüminyum)



Kanat



Ray (Alüminyum için)



Ray (PVC için)



Kanat Çıtası

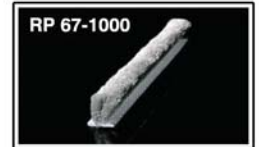
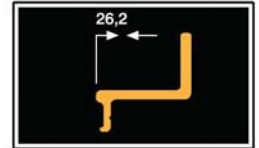
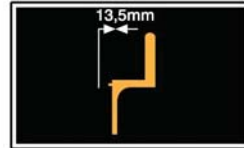
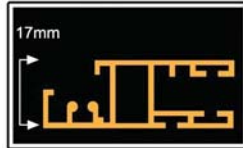

EKO (Sürme)



Köşe



Kol



Rulman (Pirinç)



Kordon



Kanat



Ray (Alüminyum için)



Ray (PVC için)

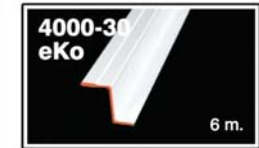

Ray (PVC için)

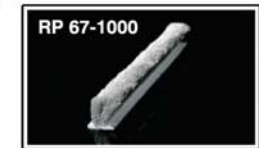
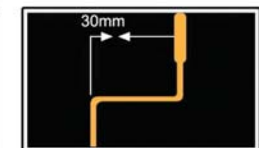
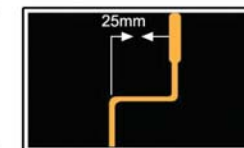
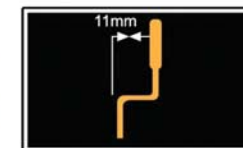
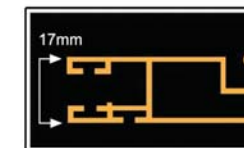

Sineklik Tüleri

Kod	Ölçü	Koli Adedi
Glasstex		
019.001	80x30	m ²
019.002	100x30	m ²
019.003	120x30	m ²
019.004	140x30	m ²
019.005	160x30	m ²
019.006	180x90	m ²



Yapıştırıcı ve Köpükler

Kod	Açıklama	Koli Adedi
E-28-275-325 177811	Akrilik Mastik Kartuş Beyaz	310 ml 20
E-28-300-307 177850	Silikon Kartuş Şeffaf	310 ml 20
E-28-450-302 585129	Poliüretan Köpük M525 EU	750 ml 12



PVC Panel

Kod	Açıklama	Koli Adedi
012.124	1500X3000 24 mm Beyaz	4,5 m ²
012.127	1200X3000 24 mm Kahverengi	3,6 m ²



012.127

012.124

Isıcam Çıtaları ve Kimyasalları

TURKO

Isı Cam Çıtaları

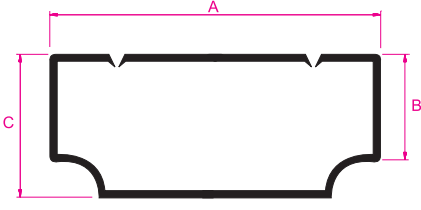

TİP	A $\pm 0,3$	B $\pm 0,3$	C $\pm 0,3$
6 mm	5,5	4,7	6,7
8 mm	7,5	4,7	6,7
9 mm	8,5	4,7	6,7
10 mm	9,5	4,7	6,7
11 mm	10,5	4,7	6,7
12 mm	11,5	4,7	6,7
14 mm	13,5	4,7	6,7
15 mm	14,5	4,7	6,7
16 mm	15,5	4,7	6,7
18 mm	17,5	4,7	6,7
20 mm	19,5	4,7	6,7



TURKO

Isı Cam Kimyasalları

Kod	Açıklama	Ağırlık
012.397	Kadmar Polikad M Çift Cam Macunu	385 kg
012.434	Kadmar IGS 100 Butil	7 kg
012.370	Turkomol Nem Alıcı	25 kg



GLASSLINE

Line Eşiksiz Kurulum

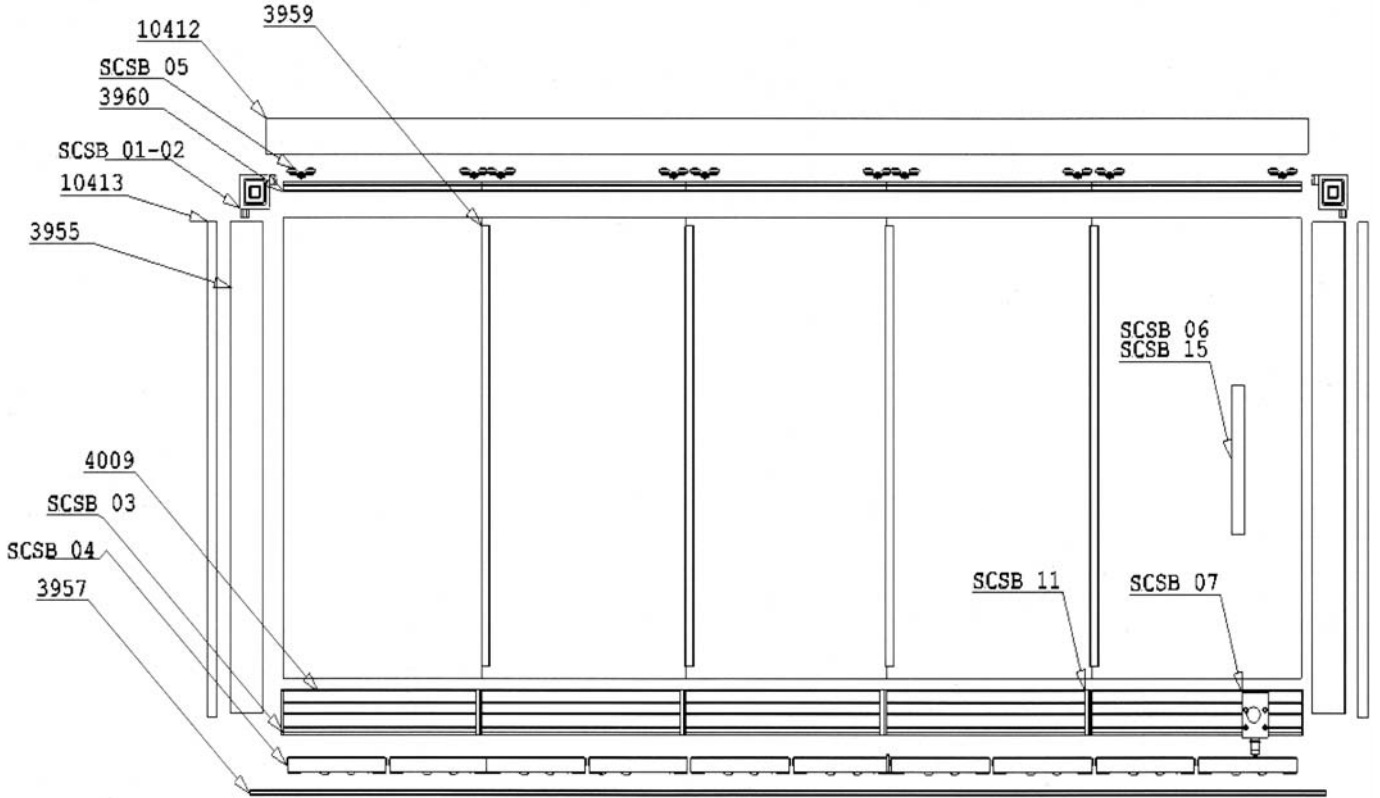

X Line Eşikli Kurulum

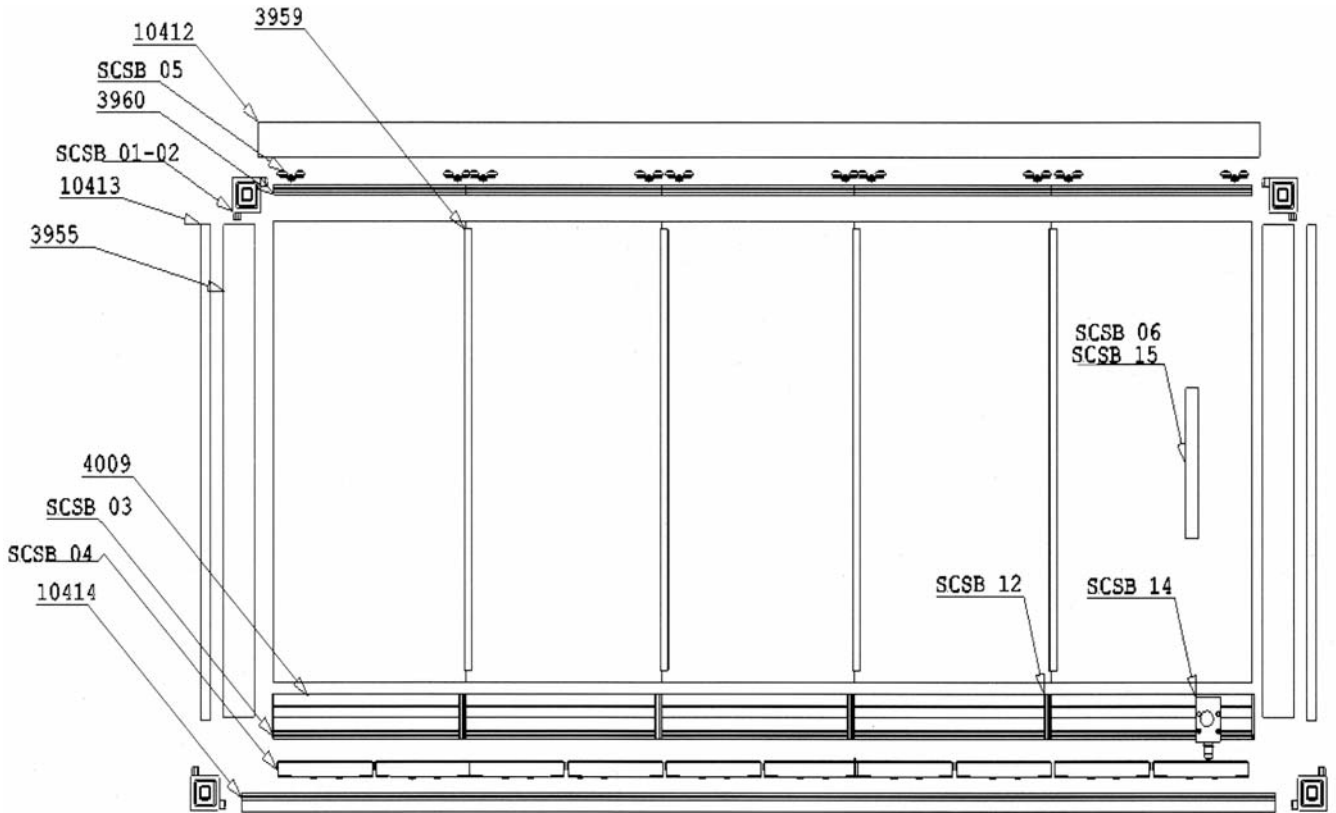

Line Eşiksiz - X Line Eşikli Sürgülü Sistem (Alüminyum Profiller)

GLASSLINE



Kod	Tanım	Paket
003957	Line Eşiksiz Ray Profili	6,5 m / 2 Ad.

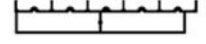

Kod	Tanım	Paket
010414	X Line Alt Eşikli Ray Profili	6,5 m / 2 Ad.

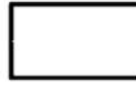

Kod	Tanım	Paket
003955	Yan U Bağlantı Profili	5,5 m / 6 Ad.



Kod	Tanım	Paket
003959	Cam Fitol Profil 8 mm	5,5 m / 4 Ad.



Kod	Tanım	Paket
003960	Üst Cam Profil 8 mm	6,5 m / 4 Ad.



Kod	Tanım	Paket
003981	Cam Fitol Profil 10 mm	5,5 m / 4 Ad.



Kod	Tanım	Paket
003982	Üst Cam Profil 10 mm	6,5 m / 4 Ad.

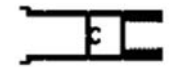

Kod	Tanım	Paket
004009	Alt Kanat Profil 8 mm	6,5 m / 4 Ad.



Kod	Tanım	Paket
010412	Üst Profil	6,5 m / 2 Ad.

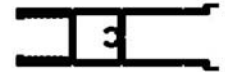

Kod	Tanım	Paket
004010	Alt Kanat Profil 10 mm	6,5 m / 4 Ad.

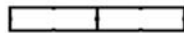

Kod	Tanım	Paket
010413	Yan Bağlantı Profili	5,5 m / 4 Ad.

GLASSLINE



Kod	Tanım	Paket
SCSB03	Alt Kanat Zamak Kapak	100 Ad.



Kod	Tanım	Paket
SCSB0102	Köşe Aparat	40 Ad.



Kod	Tanım	Paket
SCSB04	Ray Mekanizması	100 Ad.



Kod	Tanım	Paket
SCSB05	Üst Klavuz	100 Ad.



Kod	Tanım	Paket
SCSB07	Kilit	10 Ad.



Kod	Tanım	Paket
SCSB06	Kulp	50 Ad.



Kod	Tanım	Paket
SCSB11	Alt kanat Kapak (Eşiksiz)	100 Ad.



Kod	Tanım	Paket
SCSB12	Alt kanat Kapak (Eşikli)	100 Ad.



Kod	Tanım	Paket
SCSB14	Kilit (Eşikli)	10 Ad.



Kod	Tanım	Paket
SCSB15	Tekli kulp	50 Ad.



Kod	Tanım	Paket
SCCB43	Kıl Fital	200 m.



Kod	Tanım	Paket
SCCB44	Kıl Fital Yapışkanlı	200 m.

Profil Renkleri



Aksesuar Renkleri



Askılı Vitrin Sistem (Alüminyum Profiller)

GLASSLINE



Kod	Tanım	Paket
010168	Kasa Profili	6,5 m / 2 Ad.



Kod	Tanım	Paket
003678	Cam Çıtası 10 mm	6,5 m / 6 Ad.



Kod	Tanım	Paket
003689	Triptonik Profil	6,5 m / 2 Ad.



Kod	Tanım	Paket
010167	Kanat Profili	6,5 m / 2 Ad.

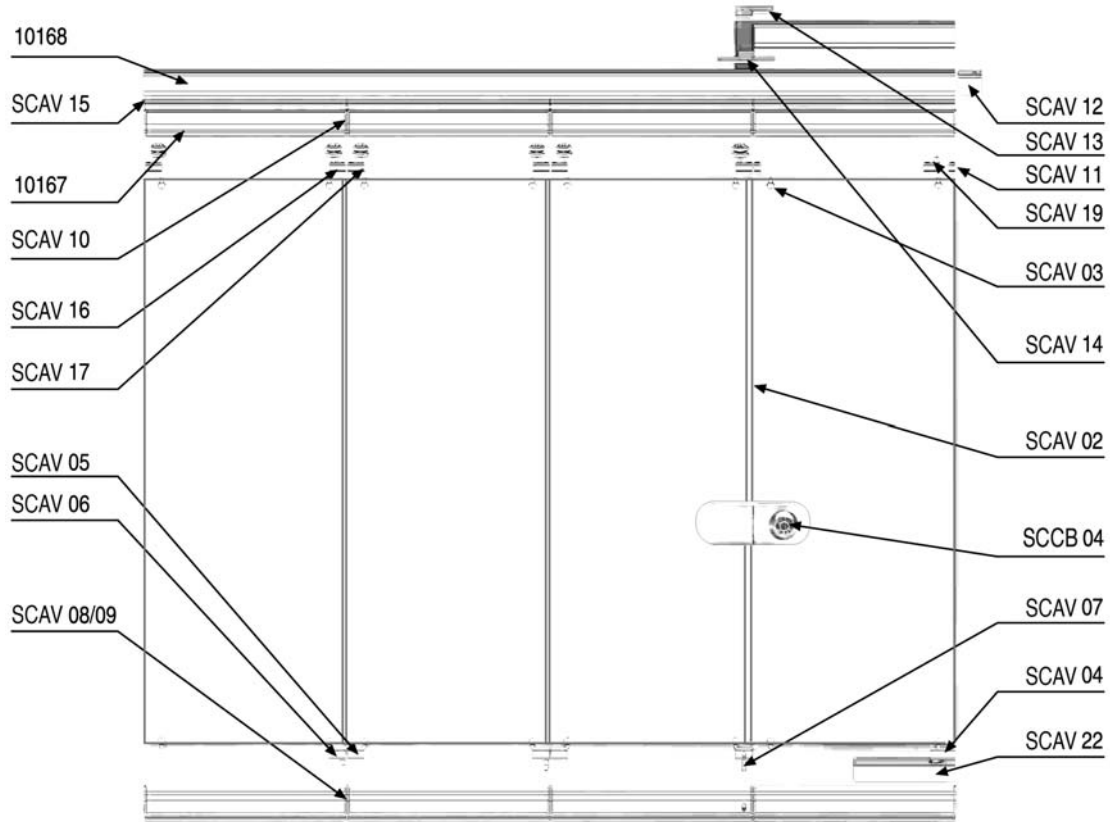

Profil Renkleri



Aksesuar Renkleri



GLASSLINE



Kod	Tanım	Paket
SCAV16	Teker Ön	20 Ad.



Kod	Tanım	Paket
SCAV17	Teker Arka	20 Ad.



Kod	Tanım	Paket
SCAV18	Çift Aksiyon Teker	20 Ad.



Kod	Tanım	Paket
SCAV08	Kanat Bitim Kapak	100 Ad.



Kod	Tanım	Paket
SCAV09	Kanat Kapak Düz	100 Ad.



Kod	Tanım	Paket
SCAV10	Kanat Kapak Delik	100 Ad.



Kod	Tanım	Paket
SCAV27	Kanat Bitim Kapak	100 Ad.



Kod	Tanım	Paket
SCAV03	Cam Tutucu	100 Ad.



Kod	Tanım	Paket
SCAV04	Hidrolik Aparat	20 Ad.



Kod	Tanım	Paket
SCAV05	Kanat Birleşim Aparat Dişi	50 Ad.



Kod	Tanım	Paket
SCAV06	Kanat Birleşim Aparat Erkek	50 Ad.



Kod	Tanım	Paket
SCAV07	Kanat Birleşim Aparat	50 Ad.



Kod	Tanım	Paket
SCAV11	Kapak Bağlantı Aparat	50 Ad.



Kod	Tanım	Paket
SCAV13	L Bağlantı Aparat	50 Ad.



Kod	Tanım	Paket
SCAV14	T Bağlantı Aparat	50 Ad.

Askılı Vitrin Sistem (Aksesuarlar)

GLASSLINE



Kod	Tanım	Paket
SCAV19	Kanat Mentеше Aparat	50 Ad.



Kod	Tanım	Paket
SCAV21	Çift Aksiyon Bağlantı	10 Ad.



Kod	Tanım	Paket
SCAV24	Kapı Alt Mentеше	50 Ad.



Kod	Tanım	Paket
SCAV25	Kapı Alt Mentеше Aparat	50 Ad.



Kod	Tanım	Paket
SCAV12	Kasa Mentеше Aparat	50 Ad.



Kod	Tanım	Paket
SCAV23	Kapı Hidrolik	2 Ad.
SCAV24	Yer Hidrolik	2 Ad.



Kod	Tanım	Paket
SCAV15	Polyemid Fitol	50 Ad.

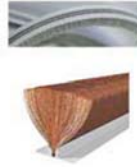

Kod	Tanım	Paket
SCCB43	Kıl Fitol	200 m.



Kod	Tanım	Paket
SCCB04	Güvenlik Anahtar	10 Ad.

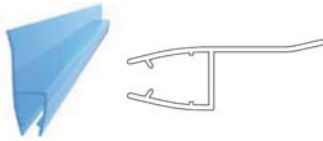

Kod	Tanım	Paket
15 SCCB17	h Şeffaf Fitol 10 mm	50 Ad.

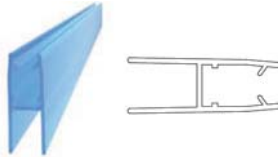

Kod	Tanım	Paket
16 SCCB17	H Şeffaf Fitol 10 mm	50 Ad.



Kod	Tanım	Paket
17 SCCB17	D Şeffaf Fitol 10 mm	50 Ad.



Kod	Tanım	Paket
18 SCCB17	Açılı Şeffaf Fitol 10 mm	50 Ad.

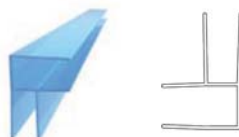

Kod	Tanım	Paket
19 SCCB17	90° Şeffaf Fitol 10 mm	50 Ad.

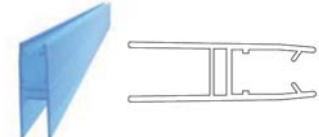

Kod	Tanım	Paket
20 SCCB17	H Double Şeffaf Fitol 10 mm	50 Ad.

GLASSLINE

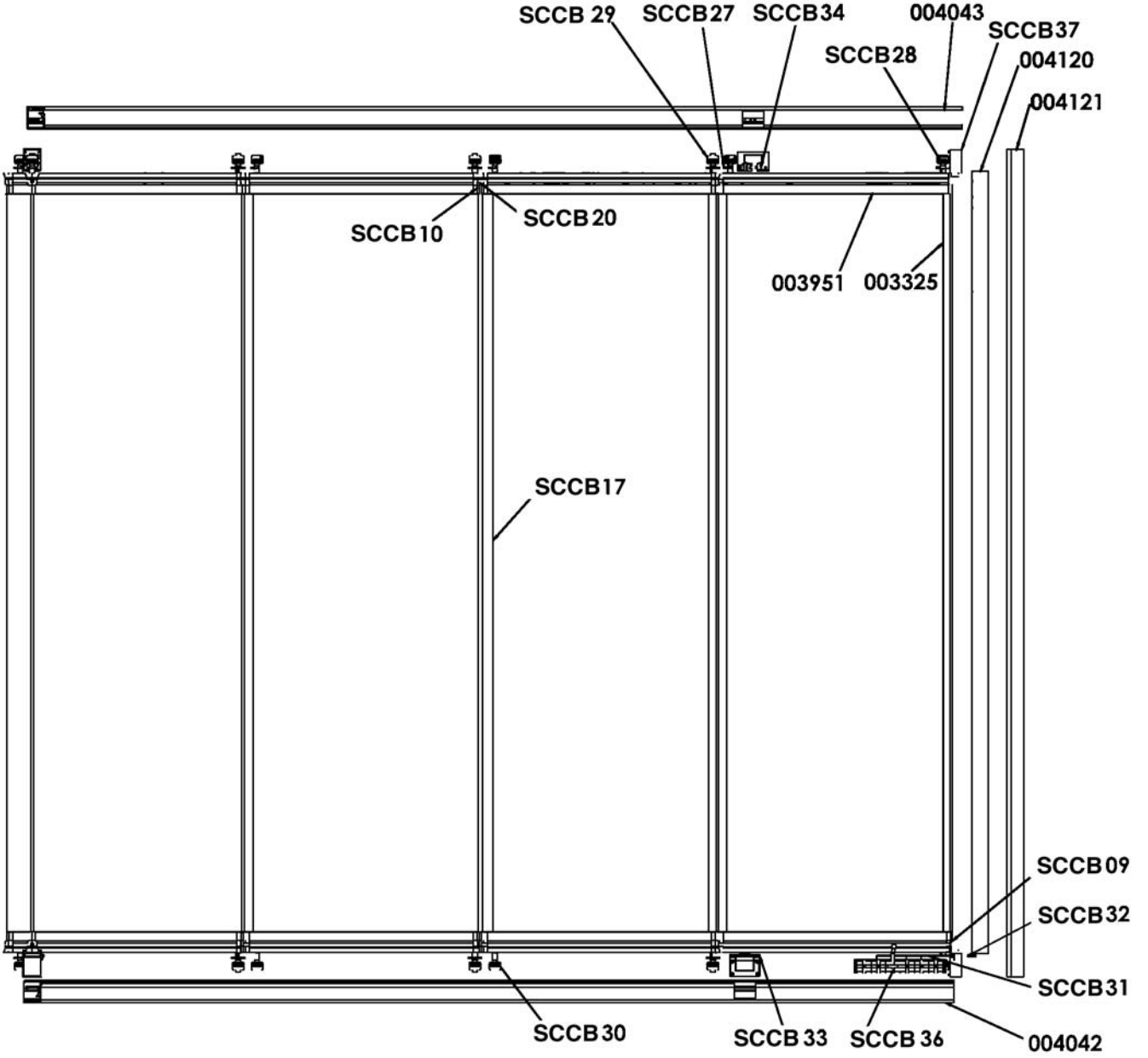

Profil Renkleri



Aksesuar Renkleri



Ultra Katlanır Sistem (Alüminyum Profiller)

GLASSLINE



Kod	Tanım	Paket
004042	Alt Kasa Profili	6,5 m / 2 Ad.



Kod	Tanım	Paket
003325	Cam Çıtası 8 mm	5,5 m / 6 Ad.

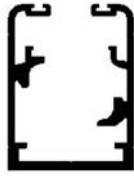

Kod	Tanım	Paket
004043	Üst Kasa Profil	6,5 m / 2 Ad.



Kod	Tanım	Paket
004122	Cam Çıtası 10 mm	5,5 m / 6 Ad.

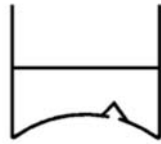

Kod	Tanım	Paket
004120	Yan Dikme	5,5 m / 6 Ad.



Kod	Tanım	Paket
004121	Duvar Dikme 1	5,5 m / 6 Ad.



Kod	Tanım	Paket
003951	Kanat Profil 8 mm	6,5 m / 4 Ad.



Kod	Tanım	Paket
004111	Kanat Profil 10 mm	6,5 m / 6 Ad.

GLASSLINE



Kod	Tanım	Paket
09 SCCB27	Teker Çıkış Kaplamalı	40 Ad.
10 SCCB27	Teker Çıkış Paslanmaz	40 Ad.



Kod	Tanım	Paket
09 SCCB28	Teker Sabit Kaplamalı	40 Ad.
10 SCCB28	Teker Sabit Paslanmaz	40 Ad.



Kod	Tanım	Paket
SCCB31	Tekerlek Fren	500 Ad.



Kod	Tanım	Paket
09 SCCB29	Teker Stop Kaplamalı	40 Ad.
10 SCCB29	Teker Stop Paslanmaz	40 Ad.



Kod	Tanım	Paket
09 SCCB30	Teker Düz Kaplamalı	40 Ad.
10 SCCB30	Teker Düz Paslanmaz	40 Ad.



Kod	Tanım	Paket
SCCB32	Kızak Stop	240 Ad.



Kod	Tanım	Paket
08 SCCB09	Bitim Kanat Kapak 8 mm	100 Ad.



Kod	Tanım	Paket
10 SCCB09	Bitim Kanat Kapak 10 mm	100 Ad.



Kod	Tanım	Paket
08 SCCB40	Kanat Kapak 8 mm Sağ	100 Ad.
09 SCCB40	Kanat Kapak 8 mm Sol	100 Ad.



Kod	Tanım	Paket
08 SCCB10	İç Kapak 8 mm	100 Ad.



Kod	Tanım	Paket
10 SCCB10	İç Kapak 10 mm	100 Ad.



Kod	Tanım	Paket
08 SCCB41	Kanat Kapak 10 mm Sağ	100 Ad.
09 SCCB41	Kanat Kapak 10 mm Sol	100 Ad.



Kod	Tanım	Paket
08 SCCB20	Dış Kapak 8 mm	100 Ad.



Kod	Tanım	Paket
08 SCCB20	Dış Kapak 10 mm	100 Ad.



Kod	Tanım	Paket
SCCB15	Gizli Kilit	100 Ad.

Askılı Vitrin Sistem (Aksesuarlar)

GLASSLINE



Kod	Tanım	Paket
SCCB33	Alt Çıkış Kapak	100 Ad.



Kod	Tanım	Paket
SCCB34	Üst Çıkış Kapak	100 Ad.



Kod	Tanım	Paket
SCCB16	Kasa Adaptörü	50 Ad.



Kod	Tanım	Paket
SCCB36	Kanal Stop	100 Ad.



Kod	Tanım	Paket
SCCB42	Kanal Stop Gövde	100 Ad.



Kod	Tanım	Paket
SCCB37	Köşe aparatı	25 Takım/4 Ad.



Kod	Tanım	Paket
SCCB18	Kilit Tel	250 m.



Kod	Tanım	Paket
SCCB04	Güvenlik Anahtar	10 Ad.



Kod	Tanım	Paket
SCCB43	Kıl Fitol	200 m.
SCCB44	Balon Fitol	200 m.

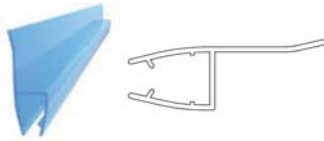

Kod	Tanım	Paket
15 SCCB17	h Şeffaf Fitol 8 mm	50 Ad.
15 SCCB17	h Şeffaf Fitol 10 mm	50 Ad.

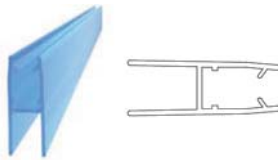

Kod	Tanım	Paket
16 SCCB17	H Şeffaf Fitol 8 mm	50 Ad.
16 SCCB17	H Şeffaf Fitol 10 mm	50 Ad.



Kod	Tanım	Paket
17 SCCB17	D Şeffaf Fitol 8 mm	50 Ad.
17 SCCB17	D Şeffaf Fitol 10 mm	50 Ad.



Kod	Tanım	Paket
18 SCCB17	Açılı Şeffaf Fitol 8 mm	50 Ad.
18 SCCB17	Açılı Şeffaf Fitol 10 mm	50 Ad.

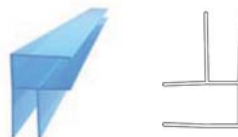

Kod	Tanım	Paket
19 SCCB17	90° Şeffaf Fitol 8 mm	50 Ad.
19 SCCB17	90° Şeffaf Fitol 10 mm	50 Ad.

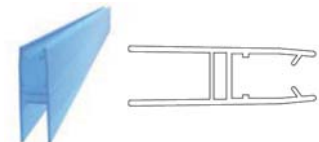

Kod	Tanım	Paket
20 SCCB17	H Double Şeffaf Fitol 8 mm	50 Ad.
20 SCCB17	H Double Şeffaf Fitol 10 mm	50 Ad.

s c h o n l i n e p v c . c o m

Kunststoff  Technologie[®]
SCHÖNLINE